

VS mini J7

Compact General Purpose Inverter

USER'S MANUAL



PREFACE

YASKAWA's VS mini J7 (hereinafter, called VS mini), is a small and simple inverter; as easy as using a contactor. This instruction manual describes installation, maintenance and inspection, troubleshooting, and specifications of the VS mini. Read this instruction manual thoroughly before operation.

OMRON YASKAWA Motion Control B.V.

General Precautions

- Some drawings in this manual are shown with the protective cover or shields removed, in order to describe detail with more clarity. Make sure all covers and shields are replaced before operating this product.
- This manual may be modified when necessary because of improvement of the product, modification, or changes in specifications. Such modifications are denoted by a revised manual No.
- To order a copy of this manual, if your copy has been damaged or lost, contact your OYMC representative.
- OYMC is not responsible for any modification of the product made by the user, since that will void your guarantee.

NOTES FOR SAFE OPERATION

Read this instruction manual thoroughly before installation, operation, maintenance or inspection of the VS mini. In this manual, NOTES FOR SAFE OPERATION are classified as “WARNING” or “CAUTION.”



Indicates a potentially hazardous situation which, if not avoided, could result in death or serious injury to personnel.



Indicates a potentially hazardous situation which, if not avoided, may result in minor or moderate injury to personnel and damage to equipment. It may also be used to alert against unsafe practices.

Even items described in  CAUTION may result in a vital accident in some situations. In either case, follow these important notes.

 : These are steps to be taken to insure proper operation.

WARNINGS FOR UL/cUL MARKING

- Do not connect or disconnect wiring, or perform signal checks while the power supply is turned ON.
- The Inverter internal capacitor is still charged even after the power supply is turned OFF. To prevent electric shock, disconnect all power before servicing the Inverter. Then wait at least one minute after the power supply is disconnected and all indicators are OFF.
- Do not perform a withstand voltage test on any part of the Inverter. This electronic equipment uses semiconductors and is vulnerable to high voltage.
- Do not remove the Digital Operator or the blank cover unless the power supply is turned OFF. Never touch the printed control board (PCB) while the power supply is turned ON.
- This Inverter is not suitable for use on a circuit capable of delivering more than 18,000 RMS symmetrical amperes, 250volts maximum (200V class units) or 18,000 RMS symmetrical amperes, 480volts maximum (400V class units).

 CAUTION

Use 75°C copper wires or equivalent. Low voltage wires shall be wired with Class I Wiring.

WARNINGS FOR CE MARKINGS

- Only basic insulation to meet the requirements of protection class I and overvoltage category II is provided with control circuit terminals. Additional insulation may be necessary in the end product to conform to CE requirements.
- For 400 V class Inverters, make sure to ground the supply neutral to conform to CE requirements.
- For conformance to EMC directives, refer to the relevant manuals for the requirements.
Document No. EZZ008389 for Japanese version,
Document No. EZZ008390 for English version

RECEIVING

CAUTION

(Ref. page)

- Do not install or operate any inverter which is damaged or has missing parts.
Failure to observe this caution may result in personal injury or equipment damage.15

MOUNTING

CAUTION

(Ref. page)

- Lift the cabinet by the heatsink. When moving the unit, never lift by the plastic case or the terminal covers. Otherwise, the main unit may be dropped causing damage to the unit.17
- Mount the inverter on nonflammable material (i.e. metal). Failure to observe this caution can result in a fire.17
- When mounting units in an enclosure, install a fan or other cooling device (open chassis to keep the intake air temperature below 50°C (122°F).
Overheating may cause a fire or damage to the unit.18
- The VS mini generates heat. For effective cooling, mount it vertically.
Refer to the figure in “Mounting Dimensions” on page 18.

WIRING

WARNING

(Ref. page)

- Only commence wiring after verifying that the power supply is turned OFF.
Failure to observe this warning can result in an electric shock or a fire.20
- Wiring should be performed only by qualified personnel.
Failure to observe this warning can result in an electric shock or a fire.20
- When wiring the emergency stop circuit, check the wiring thoroughly before operation.
Failure to observe this warning can result in personal injury.20
- For 400V class, make sure to ground the supply neutral.
Failure to observe this warning can result in an electric shock or a fire.24
- Make sure to ground the ground terminal  according to the local grounding code.
Failure to observe this warning can result in an electric shock or a fire.24



CAUTION

(Ref. page)

- **Verify that the inverter rated voltage coincides with the AC power supply voltage.**
Failure to observe this caution can result in personal injury or a fire.
- **Do not perform a withstand voltage test of the inverter.**
It may cause semi-conductor elements to be damaged.
- **Make sure to tighten terminal screws of the main circuit and the control circuit.**
Failure to observe this caution can result in a malfunction, damage or a fire.20
- **Never connect the AC main circuit power supply to output terminals U/T1, V/T2, and W/T3.**
The inverter will be damaged and invalidate the guarantee.20
- **Do not connect or disconnect wires or connectors while power is applied to the circuit.**
Failure to observe this caution can result in personal injury.
- **Do not change signals during operation.**
The machine or the inverter may be damaged.

OPERATION

WARNING

(Ref. page)

- Only turn ON the input power supply after replacing the front cover.
Do not remove the covers while current is flowing.
Failure to observe this warning can result in an electric shock.
- Never operate the digital operator or dip the switches when your hand is wet.
Failure to observe this warning can result in an electric shock.
- Never touch the terminals while current is flowing, even during inverter stopping.
Failure to observe this warning can result in an electric shock.
- When the fault retry function is selected, stand clear of the inverter or the load, since it may restart suddenly after being stopped.
(Construct machine system, so as to assure safety for personnel, even if the inverter should restart.) Failure to observe this warning can result in personal injury. 53
- When continuous operation after power recovery is selected, stand clear of the inverter or the load, since it may restart suddenly after being stopped.
(Construct machine system, so as to assure safety for personnel, even if the inverter should restart.) Failure to observe this warning can result in personal injury. 48
- Since the digital operator stop button can be disabled by a function setting, install a separate emergency stop switch.
Failure to observe this warning can result in personal injury.
- If an alarm is reset with the operation signal ON, the inverter restarts automatically. Only reset the alarm after verifying that the operation signal is OFF.
Failure to observe this warning can result in personal injury. 26



CAUTION

(Ref. page)

- Never touch the heatsink since the temperature is very high.
Failure to observe this caution can result in harmful burns to the body.
- Since it is easy to change operation speed from low to high speed, verify the safe working range of the motor and machine before operation.
Failure to observe this caution can result in personal injury and machine damage.
- Install a holding brake separately if necessary.
Failure to observe this caution can result in personal injury.
- If using an Inverter with an elevator, take safety measures on the elevator to prevent the elevator from dropping.
Failure to observe this caution can result in personal injury.
- Do not change signals during operation.
The machine or the inverter may be damaged.
- All the constants of the inverter have been preset at the factory. Do not change the settings unnecessarily.
The inverter may be damaged.27

MAINTENANCE AND INSPECTION



WARNING

- Never touch high-voltage terminals in the inverter.
Failure to observe this warning can result in an electric shock.
- Disconnect all power before performing maintenance or inspection.
Then wait at least one minute after the power supply is disconnected and all LEDs and CHARGE LED are extinguished.
The capacitors are still charged and can be dangerous.



WARNING

(Ref. page)

- Do not perform withstand voltage test on any part of the VS mini.

This electronic equipment uses semiconductors and is vulnerable to high voltage.

- Only authorized personnel should be permitted to perform maintenance, inspections or parts replacement.

[Remove all metal objects (watches, bracelets, etc.) before operation.]

(Use tools which are insulated against electric shock.)

Failure to observe this warning can result in an electric shock.84



CAUTION

(Ref. page)

- The control PC board employs CMOS ICs.

Do not touch the CMOS elements.

They are easily damaged by static electricity.

- Do not connect or disconnect wires, cooling fan or connectors while power is applied to the circuit.

Failure to observe this caution can result in personal injury.84

Others



WARNING

- Never modify the product.

Failure to observe this warning can result in an electric shock or personal injury and will invalidate the guarantee.

WARNING DISPLAY

A warning label is displayed on the front cover of the inverter, as shown below. Follow these instructions when handling the inverter.

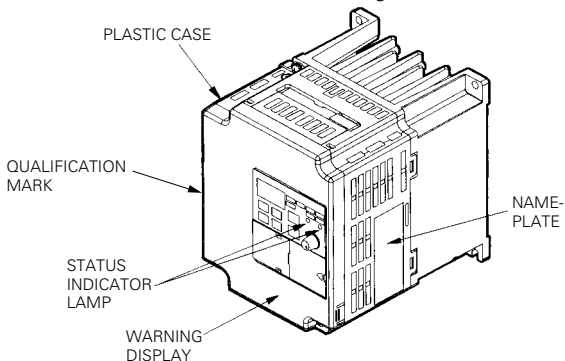

Warning Display (Back of this manual)

■ Japanese/French Warning Display

An English warning display is on the front panel of the inverter. If you need Japanese or French warning display, a sheet of labels is included. Place it over the English warning display.



English

French

Japanese

Warning Display

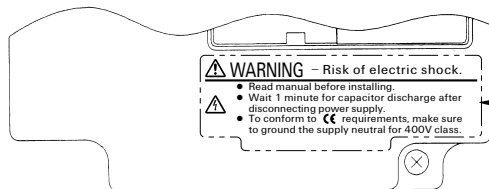

Example of 200V class, 3-phase, 1.5 kW inverter

CONTENTS

NOTES FOR SAFE OPERATION.....	3
1. RECEIVING.....	15
■ Checking the Name Plate	15
2. IDENTIFYING THE PARTS.....	16
3. MOUNTING.....	17
■ Choosing a Location to Mount the Inverter.....	17
■ Mounting Dimensions.....	18
■ Mounting/Removing Components	19
4. WIRING.....	20
■ Wiring Instructions	20
■ Wire and Terminal Screw Sizes.....	21
■ Wiring the Main Circuit	24
■ Wiring the Control Circuit	25
■ Wiring Inspection.....	26
5. OPERATING THE INVERTER	27
■ Test Run	27
■ Operating the Digital Operator	29
■ LED Description.....	31
■ Simple Data Setting	35
6. PROGRAMMING FEATURES.....	36
■ Constant Set-up and Initialization	36
■ Selecting V/f pattern	37
■ Switching LOCAL/REMOTE Modes.....	40
■ Selecting Run/Stop Commands.....	41
■ Selecting Frequency Reference.....	42
■ Setting Operation Conditions	43
Reverse run prohibit	43
Multi-step speed selection.....	43
Operating at low speed.....	44
Adjusting speed setting signal.....	45
Adjusting frequency upper and lower limits	47
Using two accel/decel times	47

Automatic restart after momentary power loss	48
Soft-start characteristics	49
Torque detection	50
Frequency detection	52
Jump frequencies	53
Continuing operation by automatic fault reset	53
Operating coasting motor without trip	54
Holding accel/decel temporarily	55
Using frequency meter or ammeter	56
Calibrating frequency meter or ammeter	56
Reducing motor noise or leakage current	57
Operator stop key selection	59
■ Selecting Stopping Method	60
Selecting stopping method	60
Applying DC injection braking	61
■ Building Interface Circuits with External Devices	62
Using input signals	62
Using output signals	65
■ Setting Frequency by Current Reference Input	67
■ Preventing motor from stalling (Current limit)	69
■ Decreasing Motor Speed Fluctuation	71
Slip compensation	71
■ Motor Protection	72
Motor overload detection	72
■ Selecting Cooling Fan Operation	73
■ Using MEMOBUS (MODBUS) Communications (Optional)	74
MEMOBUS (MODBUS) communications	74
Communication specifications	74
■ Using Constant Copy Function	75
Constant Copy function	75
READ function	77
COPY function	78
VERIFY function	80
Inverter capacity display	81
Software No. display	82

7. MAINTENANCE AND INSPECTION	84
■ Periodical Inspection	84
■ Part Replacement	84
8. FAULT DIAGNOSIS	87
■ Protective and Diagnostic Function	87
■ Troubleshooting	95
9. SPECIFICATIONS	98
■ Standard Specifications (200V Class)	98
■ Standard Specifications (400V Class)	101
■ Standard Wiring	104
■ Sequence Input Connection with NPN/PNP Transistor	106
■ Dimensions/Heat Loss	109
■ Recommended Peripheral Devices	111
■ Constants List	113

1. RECEIVING

After unpacking the VS mini, check the following :

- Verify that the part numbers match your purchase order or packing slip.
- Check the unit for physical damage that may have occurred during shipping.

If any part of VS mini is missing or damaged, call for service immediately.

■ Checking the Name Plate

Example of 3-phase, 200VAC, 0.1kW (0.13HP)

INVERTER MODEL	→	MODEL : CIMR-J7AZ20P1	SPEC : 20P10	
INPUT SPEC.	→	INPUT : AC3PH 200-230V 50/60Hz 1, 1A		
OUTPUT SPEC.	→	OUTPUT : AC3PH 0-230V 0-400Hz 0, 0.8A 0, 3kVA		
LOT NO.	→	LOT NO :	MASS : 0, 5 k g	← MASS
SERIAL NO.	→	SER NO :	PRG :	← SOFTWARE NO.
		FILE NO : E131457	INSTALLATION CATEGORY II	
		TP20	YASKAWA ELECTRIC CORPORATION JAPAN	

MODEL

CIMR — J 7 A Z 2 0 P 1	
Inverter	→ CIMR
VS mini J7 Series	→ J 7 A
No. Type	→ P 1
A	Digital operator provided (with potentiometer)
No.	Applicable maximum motor output
	200V class 400V class
OP1	0.1kW —
OP2	0.25kW 0.37kW
OP4	0.55kW 0.55kW
OP7	1.1kW 1.1kW
1P5	1.5kW 1.5kW
2P2	2.2kW 2.2kW
3P0	— 3.0kW
4P0	4.0kW 4.0kW
No.	Voltage Class
B	Single-phase 200VAC
2	Three-phase 200VAC
4	Three-phase 400VAC
No.	Specifications
Z	OYMC standards

SPEC

2 0 P 1 0	
B	Single-phase 200VAC
2	Three-phase 200VAC
4	Three-phase 400VAC
No.	Applicable maximum motor output
	200V class 400V class
OP1	0.1kW —
OP2	0.25kW 0.37kW
OP4	0.55kW 0.55kW
OP7	1.1kW 1.1kW
1P5	1.5kW 1.5kW
2P2	2.2kW 2.2kW
3P0	— 3.0kW
4P0	4.0kW 4.0kW
No.	Protective structure
0	Open chassis (IP20)

2. IDENTIFYING THE PARTS

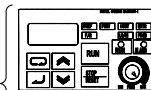
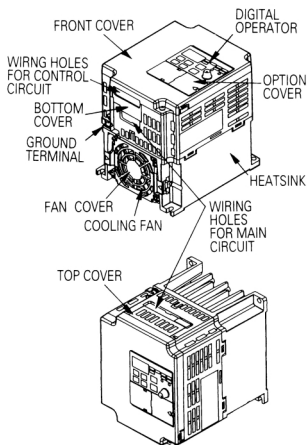

Digital operator (with potentiometer)
Used for setting or changing constants.
Frequency can be set using potentiometer.

↓ Opening the covers

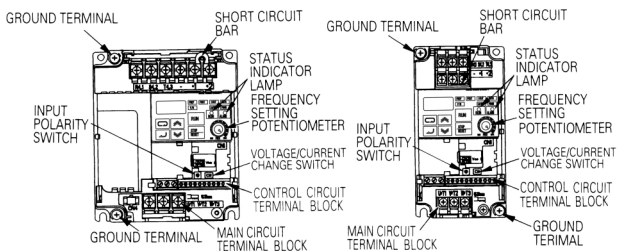

CIMR-J7**21P5, 22P2, 24P0
B0P7, B1P5
40P2, 40P4, 40P7, 41P5
42P2, 43P0, 44P0

CIMR-J7**20P1, 20P2, 20P4, 20P7,
B0P1, B0P2, B0P4

3. MOUNTING

■ Choosing a Location to Mount the Inverter

Be sure the inverter is protected from the following conditions :

- Extreme cold and heat. Use only within the ambient temperature range :
-10 to +50°C (14 to 122°F)
- Rain, moisture
- Oil sprays, splashes
- Salt spray
- Direct sunlight. (Avoid using outdoors)
- Corrosive gases (e.g. sulfurized gas) or liquids
- Dust or metallic particles in the air.
- Physical shock, vibration.
- Magnetic noise. (Example : welding machines, power devices, etc.)
- High humidity.
- Radioactive substances.
- Combustibles : thinner, solvents, etc.

■ Mounting Dimensions

To mount the VS mini, dimensions as shown below are required.

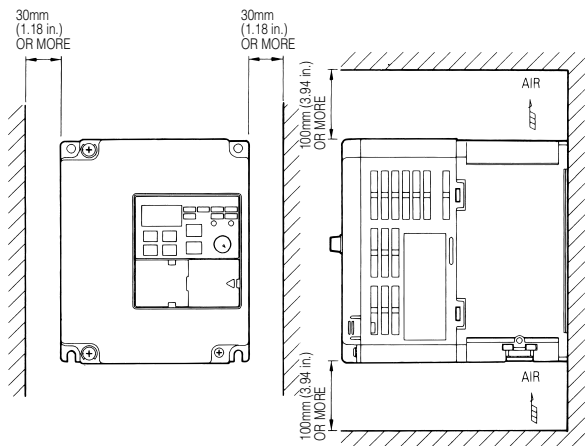

■ Mounting / Removing Components

Removing and Mounting Digital Operator and Covers

- **Removing front cover**

Use a driver to loosen the screw on the front cover surface to direction 1 to remove it. Then press the right and left sides to direction 2 and lift the front cover to direction 3.

- **Mounting front cover**

Insert the tab of the upper part of the front cover into the groove of the inverter, and press the lower part of the front cover onto the plastic case until the cover snaps shut. Then, tighten the screws.

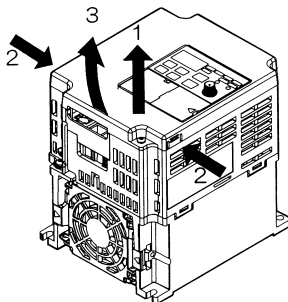

- **Removing option cover**

After removing front cover, remove the option cover to direction 2 with section A as a supporting point.

- **Mounting option cover**

Mount the terminal cover in the descending order of the above procedure for removal.

- **Removing upper/bottom covers**

After removing front cover, lift the covers to direction 1.

- **Mounting upper/bottom covers**

Mount the front cover in the descending order of the above procedure for removal.

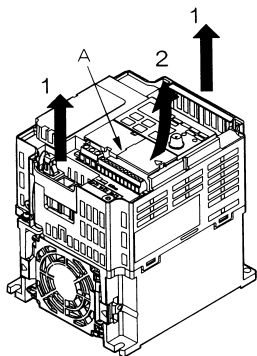

4. WIRING

■ Wiring Instructions

- (1) Always connect the power input terminals R/L1, S/L2, and T/L3 (R/L1, S/L2 for single-phase) and power supply via a molded-case circuit breaker (MCCB) or a fuse. Never connect them to terminals U/T1, V/T2, W/T3, -, +1 or +2.

Refer to page 111 for recommended peripheral devices. For single-phase inverters, always use terminals R/L1 and S/L2. Never connect to terminal T/L3.

Inverter Power Supply Connection Terminals

200V 3-phase Input Power Supply Specification Product CIMR-J7□□2□□□	200V Single Input Power Supply Specification Product CIMR-J7□□B□□□	400V 3-phase Input Power Supply Specification Product CIMR-J7□□4□□□
Connect to R/L1, S/L2, T/L3	Connect to R/L1, S/L2	Connect to R/L1, S/L2, T/L3

- (2) Connect the motor wiring to terminals U/T1, V/T2 and W/T3 on the main circuit output side (bottom of the inverter).
- (3) If the wiring distance between inverter and motor is long, reduce the inverter carrier frequency. For details, refer to “Reducing motor noise or leakage current (n46)” on page 57.
- (4) Control wiring must be less than 50m (164ft) in length and separate from the power wiring. Use twisted-pair shielded wire when inputting the frequency signal externally.
- (5) Tighten the screws on the main circuit and control circuit terminals.
- (6) Do not connect or disconnect wiring, or perform signal check while the power supply is turned ON.
- (7) For 400V class inverters, make sure to ground the supply neutral to conform to CE requirements.
- (8) Only basic insulation to meet the requirements of protection class 1 and overvoltage category II is provided with control circuit terminals. Additional insulation may be necessary in the end product to conform to CE requirements.
- (9) A closed-loop connector should be used when wiring to the main circuit terminal.
- (10) Voltage drop should be considered when determining wire size.

Voltage drop can be calculated using the following equation:

Phase-to phase voltage drop (V)

$$= \sqrt{3} \times \text{wire resistance } (\Omega/\text{km}) \times \text{wiring distance (m)} \times \text{current (A)} \times 10^{-3}$$

Select a wire size so that voltage drop will be less than 2% of the normal rated voltage.

■ Wire and Terminal Screw Sizes

1. Control Circuit

Model	Terminal Symbol	Screw	Tight Torque N·m (lb·in)	Wire				Type
				Applicable size		Recommended size		
				mm ²	AWG	mm ²	AWG	
Common to all models	MA, MB, MC	M3	0.5 to 0.6 (4.44 to 5.33)	twisted wire 0.5 to 1.25 single 0.5 to 1.25	20 to 16 20 to 16	0.75	18	Shielded wire or equivalent
	S1 to S5, SC, FS, FR, FC, AM, AC	M2	0.22 to 0.25 (1.94 to 2.21)	twisted wire 0.5 to 0.75 single 0.5 to 1.25	20 to 18 20 to 16	0.75	18	

2. Main Circuit 200V Class 3-phase Input Series

Model	Terminal Symbol	Screw	Tightening Torque N·m (lb·in)	Wire				Type
				Applicable size		Recommended size		
				mm ²	AWG	mm ²	AWG	
CIMR-J7AZ 20P1	R/L1,S/L2,T/L3, -,+1,+2, U/T1,V/T2,W/T3 ⊕	M3.5	0.8 to 1.0 (7.1 to 8.88)	0.75 to 2	18 to 14	2	14	600V vinyl-sheathed wire or equivalent
CIMR-J7AZ 20P2	R/L1,S/L2,T/L3, -,+1,+2, U/T1,V/T2,W/T3 ⊕	M3.5	0.8 to 1.0 (7.1 to 8.88)	0.75 to 2	18 to 14	2	14	
CIMR-J7AZ 20P4	R/L1,S/L2,T/L3, -,+1,+2, U/T1,V/T2,W/T3 ⊕	M3.5	0.8 to 1.0 (7.1 to 8.88)	0.75 to 2	18 to 14	2	14	
CIMR-J7AZ 20P7	R/L1,S/L2,T/L3, -,+1,+2, U/T1,V/T2,W/T3 ⊕	M3.5	0.8 to 1.0 (7.1 to 8.88)	0.75 to 2	18 to 14	2	14	
CIMR-J7AZ 21P5	R/L1,S/L2,T/L3, -,+1,+2, U/T1,V/T2,W/T3 ⊕	M3.5	0.8 to 1.0 (7.1 to 8.88)	2 to 5.5	14 to 10	2	14	
CIMR-J7AZ 22P2	R/L1,S/L2,T/L3, -,+1,+2, U/T1,V/T2,W/T3 ⊕	M3.5	0.8 to 1.0 (7.1 to 8.88)	2 to 5.5	14 to 10	3.5	14	
CIMR-J7AZ 24P0	R/L1,S/L2,T/L3, -,+1,+2, U/T1,V/T2,W/T3 ⊕	M4	1.2 to 1.5 (10.7 to 13.3)	2 to 5.5	14 to 10	5.5	10	

Note : The wire size is set for copper wires at 75°C (160°F).

200V Class Single-phase Input Series

Model	Terminal Symbol	Screw	Tightening Torque N·m (lb·in)	Wire				Type
				Applicable size		Recommended size		
				mm ²	AWG	mm ²	AWG	
CIMR-J7AZ B0P1	R/L1,S/L2,T/L3, -,+1,+2, U/T1,V/T2,W/T3	M3.5	0.8 to 1.0 (7.1 to 8.88)	0.75 to 2	18 to 14	2	14	600V vinyl- sheathed wire or equivalent
	⊕							
CIMR-J7AZ B0P2	R/L1,S/L2,T/L3, -,+1,+2, U/T1,V/T2,W/T3	M3.5	0.8 to 1.0 (7.1 to 8.88)	0.75 to 2	18 to 14	2	14	
	⊕							
CIMR-J7AZ B0P4	R/L1,S/L2,T/L3, -,+1,+2, U/T1,V/T2,W/T3	M3.5	0.8 to 1.0 (7.1 to 8.88)	0.75 to 2	18 to 14	2	14	
	⊕							
CIMR-J7AZ B0P7	R/L1,S/L2,T/L3, -,+1,+2, U/T1,V/T2,W/T3	M3.5	0.8 to 1.0 (7.1 to 8.88)	2 to 5.5	14 to 10	3.5	12	
						2	14	
						⊕		
CIMR-J7AZ B1P5	R/L1,S/L2,T/L3, -,+1,+2, U/T1,V/T2,W/T3	M3.5	0.8 to 1.0 (7.1 to 8.88)	2 to 5.5	14 to 10	5.5	10	
						2	14	
						⊕		

Notes : 1. The wire size is set for copper wires at 75°C (160°F).

2. Three-phase input is also available for single-phase input series.

400V Class 3-phase Input Series

Model	Terminal Symbol	Screw	Tightening Torque N·m (lb·in)	Wire				Type
				Applicable size		Recommended size		
				mm ²	AWG	mm ²	AWG	
CIMR-J7AZ 40P2	R/L1,S/L2,T/L3, -,+1,+2, U/T1,V/T2,W/T3	M3.5	0.8 to 1.0 (7.1 to 8.88)	2 to 5.5	14 to 10	2	14	600V vinyl- sheathed wire or equivalent
	⊕							
CIMR-J7AZ 40P4	R/L1,S/L2,T/L3, -,+1,+2, U/T1,V/T2,W/T3	M3.5	0.8 to 1.0 (7.1 to 8.88)	2 to 5.5	14 to 10	2	14	
	⊕							
CIMR-J7AZ 40P7	R/L1,S/L2,T/L3, -,+1,+2, U/T1,V/T2,W/T3	M3.5	0.8 to 1.0 (7.1 to 8.88)	2 to 5.5	14 to 10	2	14	
	⊕							
CIMR-J7AZ 41P5	R/L1,S/L2,T/L3, -,+1,+2, U/T1,V/T2,W/T3	M3.5	0.8 to 1.0 (7.1 to 8.88)	2 to 5.5	14 to 10	2	14	
	⊕							
CIMR-J7AZ 42P2	R/L1,S/L2,T/L3, -,+1,+2, U/T1,V/T2,W/T3	M4	1.2 to 1.5 (10.65 to 13.31)	2 to 5.5	14 to 10	2	14	
	⊕							
CIMR-J7AZ 43P0	R/L1,S/L2,T/L3, -,+1,+2, U/T1,V/T2,W/T3	M4	1.2 to 1.5 (10.65 to 13.31)	2 to 5.5	14 to 10	2	14	
	⊕					3.5	12	
CIMR-J7AZ 44P0	R/L1,S/L2,T/L3, -,+1,+2, U/T1,V/T2,W/T3	M4	1.2 to 1.5 (10.65 to 13.31)	2 to 5.5	14 to 10	2	14	
	⊕					3.5	12	

Note : The wire size is set for copper wires at 75°C (160°F).

■ Wiring the Main Circuit

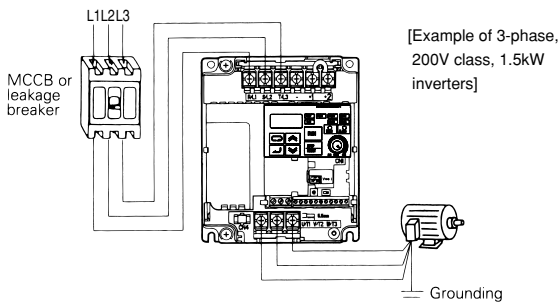

• Main circuit input power supply

Always connect the power supply line to input terminals R/L1, S/L2, and T/L3 [R/L1, S/L2 for single-phase inverters]. Never connect them to terminal U/T1, V/T2, W/T3, -, +1, or +2. Otherwise the inverter may be damaged.

NOTE For single-phase inverters, always use terminals R/L1 and S/L2. Never connect to terminal T/L3.

• Grounding (Use ground terminal ⊕.)

Make sure to ground the ground terminal ⊕ according to the local grounding code. Never ground the VS mini in common with welding machines, motors, or other electrical equipment.

When several VS mini units are used side by side, ground each unit as shown in examples. Do not loop the ground wires.

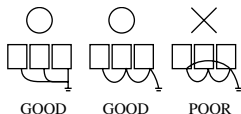

• Inverter output

Connect the motor terminals to U/T1, V/T2, W/T3.

Wiring the main circuit terminals

Pass the cables through wiring hole and connect. Be sure to mount the cover in its original position.

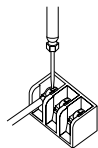

Connect with a Phillips (plus) screwdriver.

■ Wiring the Control Circuit

Only basic insulation is provided for the control circuit terminals. Additional insulation may be necessary in the end product.

• Control circuit terminals

Pass the cable through wiring hole and connect. Be sure to mount the covers on its original position.

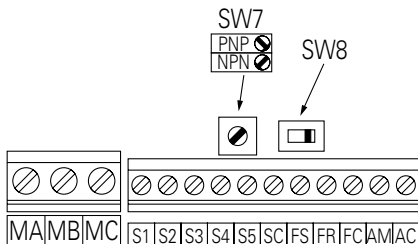

* SW7 can be changed according to sequence input signal (S1 to S5) polarity.

0V common: NPN side (factory setting)

+24 common: PNP side

Refer to page 106 for SW7.

Refer to page 67 for SW8.

Wiring the control circuit terminals

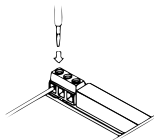

Screwdriver blade width

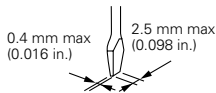

Insert the wire into the lower part of the terminal block and connect it tightly with a screwdriver.

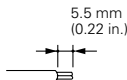

Wire sheath strip length must be 5.5mm (0.22in.).

Open the front cover and verify that the strip length is 5.5mm. (0.22in.)

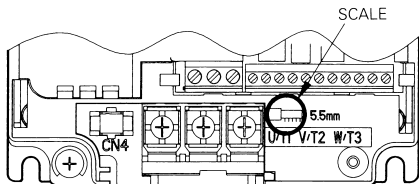

■ Wiring Inspection

After completing wiring, check the following :

- Wiring is proper.
- Wire clippings or screws are not left in the unit.
- Screws are securely tightened.
- Bare wire in the terminal does not contact other terminals.



If the FWD (REV) run command is given during the operation reference selection (n02=1) from the control circuit terminal, the motor will start automatically after the main circuit input power supply is turned ON.

5. OPERATING THE INVERTER

■ Test Run

The inverter operates by setting the frequency (speed).

There are three types of operation modes for the VS mini :

- ① Run command from the digital operator (potentiometer/digital setting).
- ② Run command from the control circuit terminal.
- ③ Run command from communications (MEMOBUS communications)

Prior to shipping, the drive is set up to receive run command and frequency reference from the operator. Below are instructions for running the VS mini using the digital operator (with potentiometer). For instructions on operation, refer to page 35.

Operation reference or frequency reference constants can be selected separately as shown below.

Name	Constant
Run Command Selection	n02 = 0 --- Enables operator RUN, STOP/RESET = 1 --- Enables control circuit terminal run/stop = 2 --- Enables communications (MEMOBUS communications)
Frequency Reference Selection	n03 = 0 --- Enables operator volume = 1 --- Enables frequency reference 1 (constant n21) = 2 --- Enables voltage reference (0 to 10V) of control circuit terminal = 3 --- Enables current reference (4 to 20mA) of control circuit terminal = 4 --- Enables current reference (0 to 20mA) of control circuit terminal = 6 --- Enables communications (MEMOBUS communications)

Operation Steps	Operator Display	12-LED Display	Status Indicator LED
1. Turn the potentiometer fully to the left before turning the power ON.	0.0		RUN ALARM
2. F/R blinks. Select FWD/REV run using keys. NOTE Never select REV when reverse run is prohibited.	<i>For</i> (Forward) or <i>rEv</i> (Reverse)		RUN ALARM
3. Press DSPL to blink FREF. Then press RUN.	0.0		RUN ALARM
4. Operates the motor by turning the potentiometer to the right. (Frequency reference corresponds to the potentiometer) NOTE If the potentiometer is switched rapidly, the motor also accelerates or decelerate rapidly corresponding to the potentiometer movement. Pay attention to load status and switch the potentiometer with the speed not to affect motor movement.	0.0 to 60.0 Minimum output frequency is 1.5Hz		RUN ALARM

Status indicator lamp : ON : Blinking : OFF

Operation Check Points

- Motor rotates smoothly.
- Motor rotates in the correct direction.
- Motor does not have abnormal vibration or noise.
- Acceleration or deceleration is smooth.
- Current matching the load flows.
- Status indicator LEDs and digital operator display are correct.

■ Operating the Digital Operator

All functions of the VS mini are set by the digital operator. Below are descriptions of the display and keypad sections.

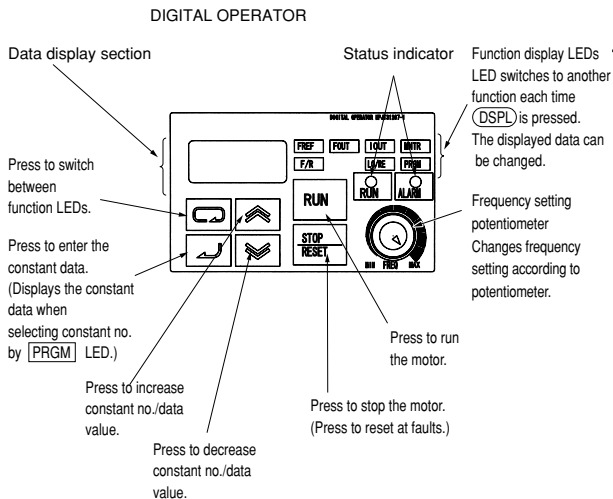



Function display LEDs (Color in parenthesis indicates the color of LED.)

FREF Frequency reference setting/monitoring (GREEN)	FOUT Output frequency monitor (GREEN)	IOUT Output current monitor (GREEN)	MNTR Multi-function monitor (GREEN)
F/R Operator RUN command FWD/REV selection (GREEN)		LO/RE LOCAL/REMOTE Selection (RED)	PRGM Constant no./data (RED)

Description of Status Indicator LEDs

There are two LEDs on the middle right section of the face of the VS mini. The inverter status is indicated by various combinations of ON, BLINKING and OFF LEDs. RUN indicator and status indicator on the **RUN** button have the same function.

 : ON  : BLINKING (Long Blinking)  : BLINKING ● : OFF

RUN ALARM ○ ○ (Green) (Red)	Operation Ready (During Stop)	Ramp to Stop	Normal Operation
	RUN ALARM  ●	RUN ALARM  ●	RUN ALARM  ●

For details on how the status indicator LEDs function at inverter faults, refer to Section 8 “FAULT DIAGNOSIS AND CORRECTIVE ACTIONS” on page 87. If a fault occurs, the ALARM LED lights.

NOTE The fault can be reset by turning ON the fault reset signal (or pressing  key on the digital operator) with the operation signal OFF or by turning OFF the power supply. If the operation signal is ON, the fault cannot be reset by the fault reset signal.

■ LED Description

By pressing (DSPL) on the digital operator, each of the function LEDs can be selected.

The following flowchart describes each function LED.

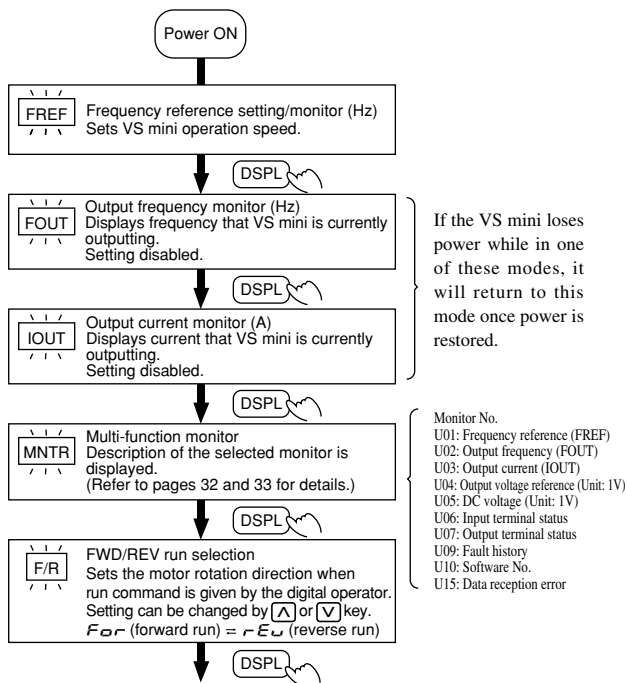

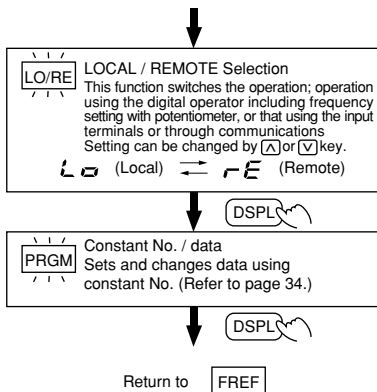

MNTR Multi-Function monitor

- Selecting monitor

Press DSPL key. When MNTR is ON, data can be displayed by selecting monitor No.

[Example] Monitoring Output Voltage Reference

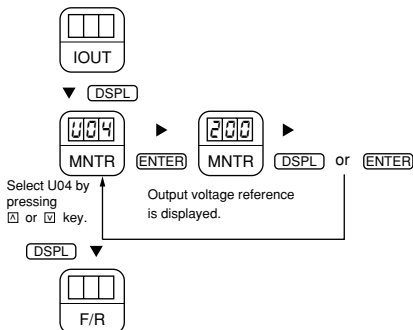

• Monitoring

Following items can be monitored by U- constants.

Constant No.	Name		Description
U01	Frequency reference (FREF)	Hz	Frequency reference can be monitored. (Same as FREF)
U02	Output frequency (FOUT)	Hz	Output frequency can be monitored. (Same as FOUT)
U03	Output current (IOUT)	A	Output current can be monitored. (Same as IOUT)
U04	Output voltage	V	Output voltage can be monitored.
U05	DC voltage	V	Main circuit DC voltage can be monitored.
U06	Input terminal status	—	Input terminal status of control circuit terminals can be monitored.
U07	Output terminal status	—	Output terminal status of control circuit terminals can be monitored.
U09	Fault history	—	Last four fault history is displayed.
U10	Software No.	—	Software No. can be checked.
U15	Data reception error	—	Contents of MEMOBUS communication data reception error can be checked. (contents of transmission register No. 003DH are the same)

Input/Output terminal status

Input terminal status

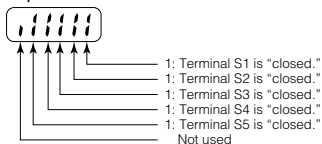

Output terminal status

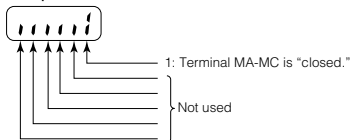

Fault history display method

Fault description is displayed when U09 is selected.

(Example)

- : Fault description
- "---" is displayed if there is no fault.
- (Refer to page 87 for details.)

Clearing fault history

Set constant n01 to 6 to clear fault history. Set data returns to its initial value after completion of 6 setting.

Note: Constant initialize (n01=12, 13) clears the fault history.

Setting and referring constants

Following shows how to select and change constants.

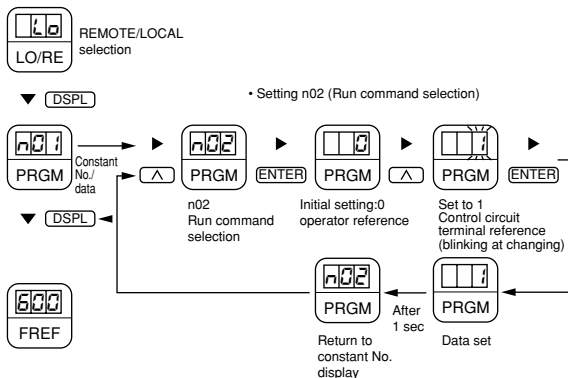

■ Simple Data Setting

Potentiometer setting (Refer to 5. OPERATING THE INVERTER) and digital setting are both available for simple accel/decel operation of the VS mini.

Frequency reference by potentiometer signal is set with initial setting (n03=0).

Factory setting of the model with operator (without potentiometer) is set by digital operator (n03=1).

Following is an example in which the function LEDs are used to set frequency reference, acceleration time, deceleration time, and motor direction.

Operation Steps	Operator Display	LED Display	Status Indicator LED
1. Turn ON the power supply.	0.0		RUN ALARM
2. Set constant n03 to 1.	1		RUN ALARM
3. Set the following constants. n16 : 15.0 (acceleration time) n17 : 5.0 (deceleration time)	15.0 5.0		RUN ALARM
4. Select forward or reverse run by pressing or key. Examine the application. (Never select REV when reverse run is prohibited.)	<i>For</i> (Forward) or <i>REV</i> (Reverse)		RUN ALARM
5. Set the reference by pressing or key.	60.0		RUN ALARM
6. Press .	0.0 to 60.0		RUN ALARM
7. Press to stop.	60.0 to 0.0		RUN ALARM

Status indicator lamp : BLINKING (Long Blinking) : BLINKING ● : OFF

6. PROGRAMMING FEATURES

Factory settings of the constants are shown as in the tables.

■ Constant Set-up and Initialization

Constant selection/initialization (n01)

The following table describes the data which can be set or read when n01 is set.

Unused constants among n01 to n79 are not displayed.

n01 Setting	Constant that can be set	Constant that can be referred
0	n01	n01 to n79
1	n01 to n79*	n01 to n79
6	Fault history cleared	
7	Not used	
12	Initialize	
13	Initialize (3-wire sequence) [†]	

* Excluding setting disabled constants.

[†] Refer to page 63.

NOTE “Err” appears on the LED display for one second and the set data returns to its initial values in the following cases :

- (1) The set values of input terminal function selection 2 to 5 (n36 to n39) are the same.
- (2) If the following conditions are not satisfied in the V/f pattern setting :
Max. output frequency (n09) \geq Max. voltage output frequency (n11)
 $>$ Mid. output frequency (n12)
 \geq Min. output frequency (n14)

For details, refer to “Adjusting torque according to application” (V/f pattern setting) on page 37.

- (3) If the following conditions are not satisfied in the Jump frequency setting :
Jump frequency 2 (n50) \leq Jump frequency 1 (n49)
- (4) If Frequency reference lower limit (n31) \leq Frequency reference upper limit (n30)
- (5) If motor rated current (n32) \leq 120% of inverter rated current

■ Selecting V/f pattern

Adjusting torque according to application

Adjust motor torque by using “V/f pattern” and “full-range automatic torque boost”.

• V/f pattern setting

Set V/f pattern by n09 to n15 as described below. Set each pattern when using a special motor (high-speed motor, etc.) or when requiring special torque adjustment of machine.

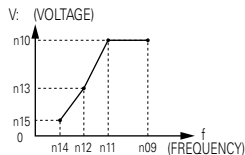

Be sure to satisfy the following conditions for the setting of n09 to n15.

$$n14 \leq n12 < n11 \leq n09$$

If $n14 = n12$ is set, the set value of n13 is disabled.

Constants No.	Name	Unit	Setting range	Initial Setting
n09	Max. output frequency	0.1Hz	50.0 to 400.0Hz	50.0Hz
n10	Max. voltage	1V	1 to 255V (1 to 510V)*	200V (24V)
n11	Max. voltage output frequency (base frequency)	0.1Hz	0.2 to 400.0Hz	50.0Hz
n12	Mid. output frequency	0.1Hz	1 to 399Hz	1.3Hz
n13	Mid. output frequency voltage	1V	1 to 255V (1 to 510V)*	12V (24V)
n14	Min. output frequency	0.1Hz	0.1 to 10.0Hz	1.3Hz
n15	Min. output frequency voltage	1V	1 to 50V (1 to 100V)*	12V (24V)

* For 400-volt class inverters

• Typical setting of V/f pattern

Set the V/f pattern according to the application as described below. For 400V class, the voltage values (n10, n13, and n15) should be doubled. When running at a frequency exceeding 50Hz/60Hz, change the maximum output frequency (n09).

Note: Be sure to set the maximum output frequency according to the motor characteristics.

(1) For general-purpose applications

Motor Specification : 60Hz

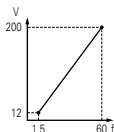

Constant	Setting
n09	60.0
n10	200
n11	60.0
n12	1.5
n13	12
n14	1.5
n15	12

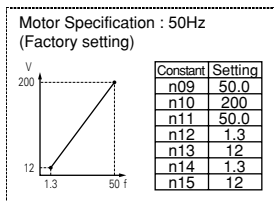

Constant	Setting
n09	50.0
n10	200
n11	50.0
n12	1.3
n13	12
n14	1.3
n15	12

(2) For fans/pumps

Motor Specification : 60Hz

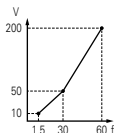

Constant	Setting
n09	60.0
n10	200
n11	60.0
n12	30.0
n13	50
n14	1.5
n15	10

Motor Specification : 50Hz

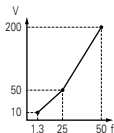

Constant	Setting
n09	50.0
n10	200
n11	50.0
n12	25
n13	50.0
n14	1.3
n15	10

(3) For applications requiring high starting torque

Motor Specification : 60Hz

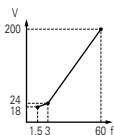

Constant	Setting
n09	60.0
n10	200
n11	60.0
n12	3.0
n13	24
n14	1.5
n15	18

Motor Specification : 50Hz

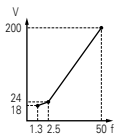

Constant	Setting
n09	50.0
n10	200
n11	50.0
n12	2.5
n13	24
n14	1.3
n15	18

Increasing voltage of V/f pattern increases motor torque, but an excessive increase may cause motor overexcitation, motor overheat or vibration.

Note : n12 is to be set to motor rated voltage.

When operating with frequency larger than 60Hz/50Hz, change only max. output frequency (n09).

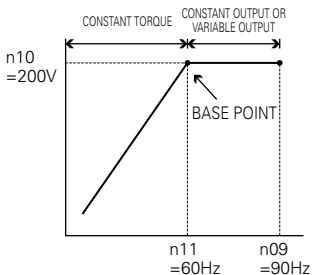

- Full-range automatic torque boost

Motor torque requirement changes according to load conditions. Full-range automatic torque boost adjusts voltage of V/f pattern according to the requirement. The VS mini automatically adjusts the voltage during constant-speed operation as well as during acceleration.

The required torque is calculated by the inverter.

This ensures tripless operation and energy-saving effects.

$$\boxed{\text{Output voltage}} \propto \boxed{\text{Torque compensation gain (n63)}} \times \boxed{\text{Required torque}}$$

Operation

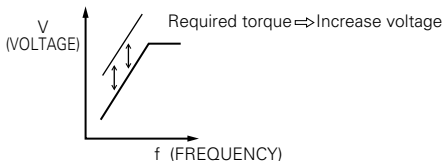

Normally, no adjustment is necessary for torque compensation gain (n63 factory setting : 1.0). When the wiring distance between the inverter and the motor is long, or when the motor generates vibration, change the automatic torque compensation gain. In these cases, set the V/f pattern (n09 to n15).

■ Switching LOCAL/REMOTE Modes

The following functions can be selected by switching the LOCAL or REMOTE mode. To select RUN/STOP commands or frequency reference, change the mode in advance depending on the following applications.

- LOCAL mode : Enables the digital operator for RUN/STOP commands and FWD/REV run commands.
Frequency reference can be set by volume or **FREF**.
- REMOTE mode : Run by the n02 setting (run command selection).
Frequency reference can be set by n03 (frequency reference selection) setting.

○ How to select LOCAL/REMOTE modes

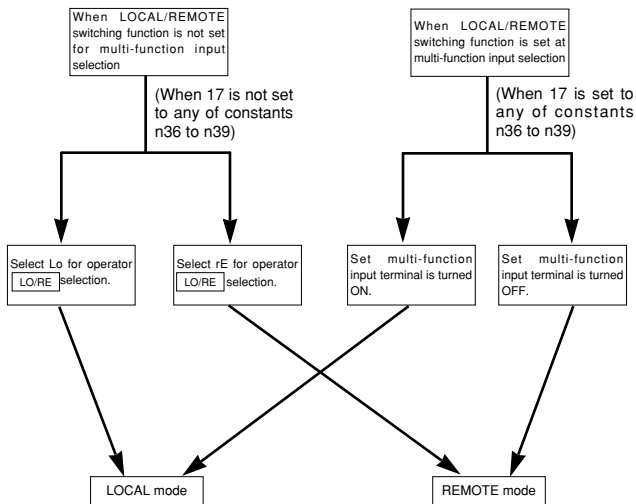

■ Selecting Run/Stop Commands

Refer to ■ Switching LOCAL / REMOTE Modes (page 40) to select either the LOCAL mode or REMOTE mode.

Operation method (RUN / STOP commands, FWD / REV run commands) can be selected by the following method.

○ LOCAL mode

When Lo (local mode) is selected for digital operator LO/RE ON mode, or when LOCAL / REMOTE switching function is set and the input terminals are turned ON, run operation is enabled by the STP or RUN of the digital operator, and FWD/REV run is enabled by F/R ON mode (using ▲ or ▼ key).

LO/RE is not effective when local / remote switching function is selected for multi-function input selection.

○ REMOTE mode

- Select remote mode.

There are following two methods to select remote mode.

1. Select rE (remote mode) for LO/RE selection.
 2. When the local / remote switching function is selected for multi-function input selection, turn OFF the input terminal to select remote mode.
- Select operation method by setting the constant n02.
 - n02=0: Enables the digital operator (same with local mode)
 - =1: Enables the multi-function input terminal (see fig. below)
 - =2: Enables communications (refer to page 74) (When option card is installed)
 - Example for using the multi-function input terminal as operation reference (two-wire sequence)

For example of three-wire sequence, refer to page 63.

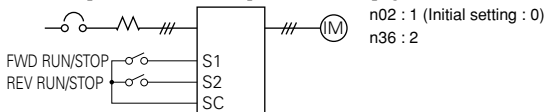

○ Operating (RUN / STOP commands) by communications (When option card is installed)

Setting constant n02 to 2 in REMOTE mode can give RUN/STOP commands by communication (MEMOBUS communications).

For details, refer to page 74.

■ Selecting Frequency Reference

Frequency reference can be selected by the following methods.

○ Setting by operator

Select REMOTE or LOCAL mode in advance. For the method for selecting the mode, refer to page 40.

LOCAL mode

Select command method by constant n07.

n07=0 : Enables the setting by potentiometer on digital operator (initial setting).

Factory setting of the model with digital operator (without potentiometer) is n07=1.

=1 : Enables the digital setting by digital operator, setting value is stored in constant n21 (frequency reference 1).

• Digital setting by digital operator

Input frequency while FREF is lit (press ENTER after setting the numeric value).

Frequency reference setting is effective when 1 is set to constant n08 instead of pressing ENTER key.

n08=0 : Enables frequency reference setting by ENTER key (initial setting).

=1 : Disable frequency reference setting by ENTER key.

REMOTE mode

Select command method by constant n03.

n03=0 : Enables frequency reference setting by potentiometer on digital operator (initial setting). Initial setting of the model with digital operator (without potentiometer) is n03=1.

=1 : Frequency reference 1 effective. (constant n21)

=2 : Voltage reference (0 to 10V) (See the figure below)

=3 : Current reference (4 to 20mA) (Refer to page 67)

=4 : Current reference (0 to 20mA) (Refer to page 67)

=6 : communication (Refer to page 74)

Example of frequency reference by voltage signal

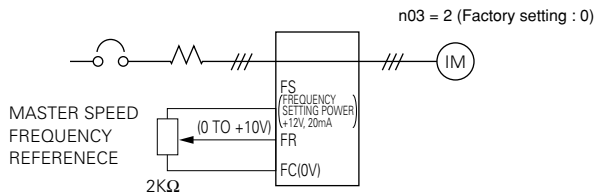

■ Setting Operation Conditions

Reverse run prohibit (n05)

“Reverse run disabled” setting does not accept a reverse run command from the control circuit terminal or digital operator. This setting is used for applications where a reverse run command can cause problems.

Setting	Description
0	Reverse run enabled.
1	Reverse run disabled.

Multi-step speed selection

By combining frequency reference and input terminal function selections, up to 9 steps of speed can be set.

8-step speed change

n02=1 (operation mode selection)
n03=1 (Frequency reference selection)
n21=25.0Hz (Frequency reference 1)
n22=30.0Hz (Frequency reference 2)
n23=35.0Hz (Frequency reference 3)
n24=40.0Hz (Frequency reference 4)
n25=45.0Hz (Frequency reference 5)
n26=50.0Hz (Frequency reference 6)
n27=55.0Hz (Frequency reference 7)
n28=60.0Hz (Frequency reference 8)

n36=2 (Multi-function contact input terminal 2)
n37=6 (Multi-function contact input terminal 3)
n38=7 (Multi-function contact input terminal 4)
n39=8 (Multi-function contact input terminal 5)

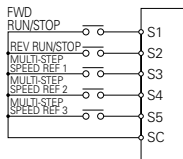

When all multi-function reference inputs are OFF, frequency reference selected by constant n03 (frequency reference selection) becomes effective.

n36=2 (Input terminal S2) Initial Setting
n37=6 (Input terminal S3) Change the setting to 6.
n38=7 (Input terminal S4) Change the setting to 7.
n39=8 (Input terminal S5) Change the setting to 8.

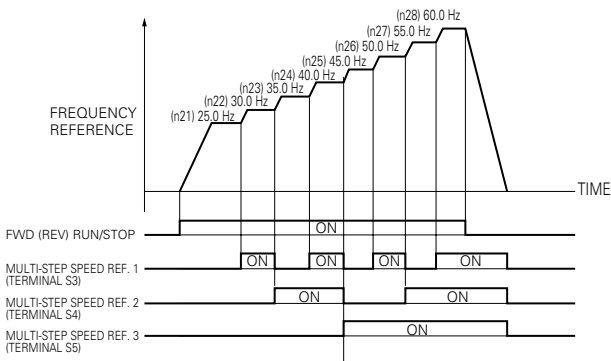

Operating at low speed

By inputting a jog command and then a forward (reverse) run command, operation is enabled at the jog frequency set in n29. When multi-step speed references 1, 2, 3 or 4 are input simultaneously with the jog command, the jog command has priority.

Name	Constant No.	Setting
Jog frequency	n29	Factory setting : 6.0Hz
Jog command	n36 to n39	Set to "10" for any constant.

Adjusting speed setting signal

To provide frequency reference by analog input of control circuit terminal FR or FC, the relationship between analog input and frequency reference can be set.

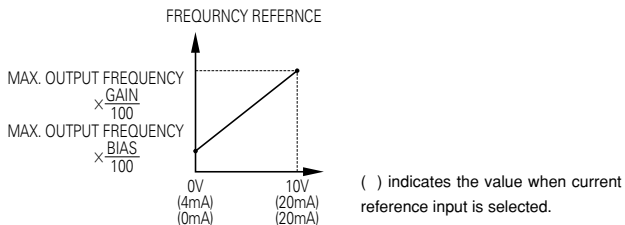

- Frequency reference gain (n41)

The analog input voltage value for the max (10V). output frequency (n09) can be set in units of 1% (max. output frequency n09=100%)

* Factory setting : 100%

- Frequency reference bias (n42)

The frequency reference provided when analog input is 0V (4mA or 0mA) can be set in units of 1%. (max. output frequency n09=100%)

* Factory setting : 0%

Typical Setting

- To operate the inverter with frequency reference of 0% to 100% at 0 to 5V input

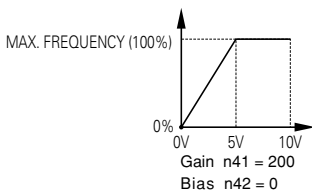

-
- To operate the inverter with frequency reference of 50% to 100% at 0 to 10V input

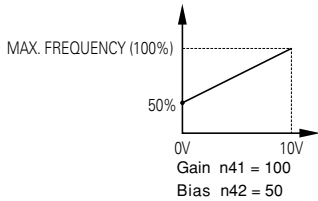

Adjusting frequency upper and lower limits

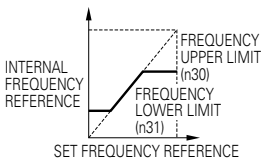

- **Frequency reference upper limit (n30)**
Sets the upper limit of the frequency reference in units of 1%.
(n09: Max. output frequency = 100%)
Factory setting: 100%
- **Frequency reference lower limit (n31)**
Sets the lower limit of the frequency reference in units of 1%.
(n09: Max. output frequency = 100%)
When operating at frequency reference 0, operation is continued at the frequency reference lower limit.
However, when frequency reference lower limit is set to less than the min. output frequency (n14), operation is not performed.
Factory setting: 0%

Using two accel/decel times

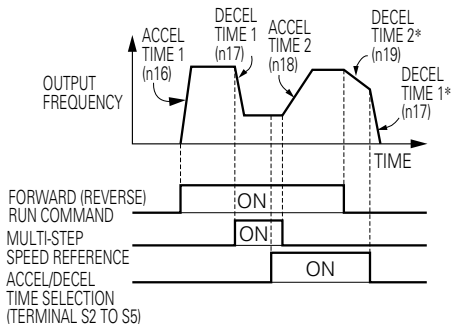

* When “deceleration to a stop” is selected (n04 = 0).

By setting input terminal function selection (either of n36 to n39) to “11 (accel/decel time select)”, accel/decel time is selected by turning ON/OFF the accel/decel time select (terminal S2 to S5).

- At OFF : n16 (accel time 1)
 n17 (decel time 1)
- At ON : n18 (accel time 2)
 n19 (decel time 2)

- **Accel time**
Set the time needed for output frequency to reach 100% from 0%.
- **Decel time**
Set the time needed for output frequency to reach 0% from 100%.
(Maximum output frequency n09=100%)

Automatic restart after momentary power loss (n47)
--

When momentary power loss occurs, operation restarts automatically.

Setting	Description
0	Continuous operation after momentary power loss not provided.
1*	Continuous operation after power recovery within momentary power loss ridethru time
2*†	Continuous operation after power recovery (Fault output not provided)

* Hold the operation command to continue the operation after recovery from a momentary power loss.

† When 2 is selected, operation restarts if power supply voltage reaches its normal level while control power supply is held. No fault signal is output.

Soft-start characteristics (n20)

To prevent shock at machine start/stop, accel/decel can be performed in S-curve pattern.

Setting	S-curve characteristic time
0	S-curve characteristic not provided
1	0.2 second
2	0.5 second
3	1.0 second

Note : S-curve characteristic time is the time from accel/decel rate 0 to a regular accel/decel rate determined by the set accel/decel time.

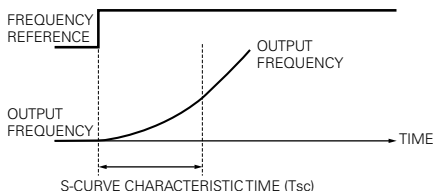

The following time chart shows FWD/REV run switching at deceleration to a stop.

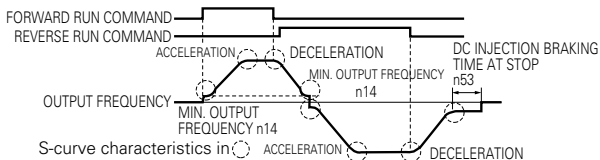

Torque detection

If an excessive load is applied to the machine, output current increase can be detected to output alarm signals to multi-function output terminals MA and MB.

To output an overtorque detection signal, set output terminal function selection n40 to “overtorque detection” [Setting:6 (NO contact) or 7 (NC contact)].

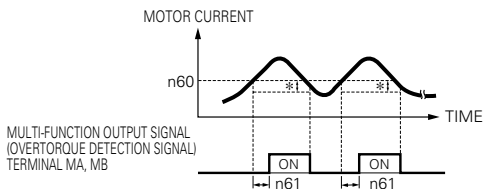

* Overtorque detection release width (hysteresis) is set at approx. 5% of inverter rated current.

- Overtorque detection function selection (n59)

Setting	Description
0	Overtorque detection not provided
1	Detected during constant-speed running, and operation continues after detection.
2	Detected during constant-speed running, and operation stops during detection.
3	Detected during running, and operation continues after detection.
4	Detected during running, and operation stops during detection.

- (1) To detect overtorque at accel/decel, set to 3 or 4.
- (2) To continue the operation after overtorque detection, set to 1 or 3.
During detection, the operator displays “**OL3**” alarm (blinking).
- (3) To halt the inverter by a fault at overtorque detection, set to 2 or 4. At detection, the operator displays “**OL3**” fault (ON).

- Overtorque detection level (n60)

Sets the overtorque detection current level in units of 1%. (Inverter rated current = 100%)

Factory setting: 160%

- Overtorque detection time (n61)

If the time when motor current exceeds the overtorque detection level (n60) is longer than overtorque detection time (n61), the overtorque detection function operates.

Factory setting : 0.1sec.

Frequency detection (n58)

Effective when either of output terminal function selection n40 is set to “frequency detection” (setting: 4 or 5). “Frequency detection” turns ON when output frequency is higher or lower than the frequency detection level (n58).

• Frequency detection 1

(Output frequency \geq Frequency detection level n58)

(Set n40 to “4.”)

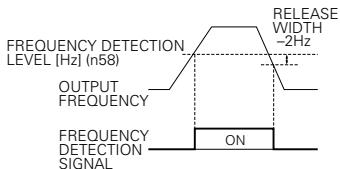

• Frequency detection 2

(Output frequency \leq Frequency detection level n58)

(Set n40 to “5.”)

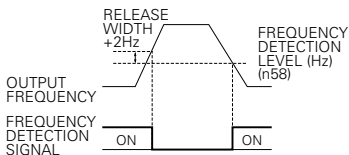

Jump frequencies (n49 to n51)

This function allows the prohibition or “jumping” of critical frequencies so that the motor can operate without resonance caused by machine systems. This function is also used for dead band control. Setting the value to 0.0Hz disables this function.

Set prohibited frequency 1 or 2 as follows :

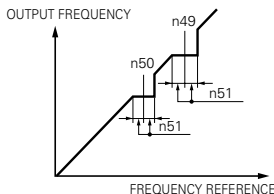

$$n49 \geq n50$$

If this condition is not satisfied the inverter displays *ERR* for one second and restores the data to original settings.

Operation is prohibited within jump frequency range.

However, motor operates without jumping during accel/decel.

Continuing operation by automatic fault reset (n48)

Sets the inverter to restart and reset fault detection after a fault occurs.

The number of self-diagnosis and retry attempts can be set at n48 up to 10.

The inverter automatically restarts after the following faults occur :

OC (overcurrent)

GF (ground fault)

OV (overvoltage)

The number of retry attempts are cleared to 0 in the following cases :

- (1) If no other fault occurs within 10 minutes after retry
- (2) When the fault reset signal is ON after the fault is detected
- (3) Power supply is turned OFF

Operating coasting motor without trip

To operate coasting motor without trip, use the speed search command or DC injection braking at start.

• Speed search command

Restarts a coasting motor without stopping it. This function enables smooth switching between motor commercial power supply operation and inverter operation.

Set input terminal function selection (n36 to n39) to “14” (search command from maximum output frequency) or “15” (search command from set frequency).

Build a sequence so that FWD (REV) run command is input at the same time as the search command or after the search command. If the run command is input before the search command, the search command becomes disabled.

• Time chart at search command input

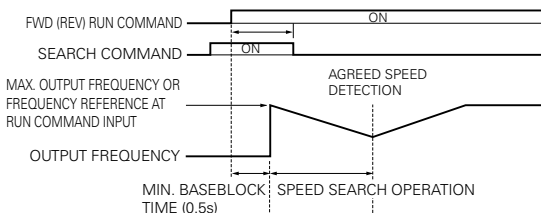

• DC injection braking at start (n52, n54)

Restarts a coasting motor after stopping it. Set the DC injection braking time at start in n54 in units of 0.1 second. Set DC injection braking current in n52 in units of 1% (inverter rated current =100%). When the setting of n54 is “0”, DC injection braking is not performed and acceleration starts from the minimum output frequency.

When n52 is set to 0, acceleration starts from the minimum output frequency after the baseblocking for n54 setting time.

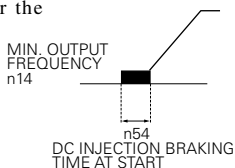

Holding accel/decel temporarily

To hold acceleration or deceleration, input accel/decel hold command. The output frequency is maintained when the accel/decel hold command is input during acceleration or deceleration.

When the stop command is input during accel/decel prohibition command input, accel/decel hold is released and operation ramps to stop.

Set multi-function input terminal selection (n36 to n39) to 16 (accel/decel hold command).

Time chart at accel/decel hold command input

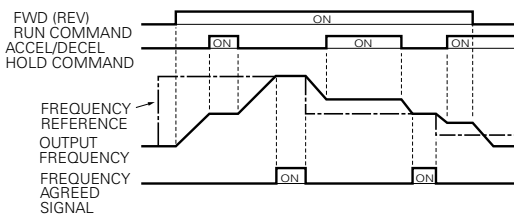

Note : When the FWD (REV) run command is input along with the accel/decel hold command, the motor does not operate. However, when frequency reference lower limit (n31) is set greater than or equal to min. output frequency (n14), the motor operates at frequency reference lower limit (n31).

Using frequency meter or ammeter (n44)

Selects to output either output frequency or output current to analog output terminals AM-AC for monitoring.

Setting	Description
0	Output frequency
1	Output current

In initial setting, analog voltage of approx. 10V is output when output frequency (output current) is 100%.

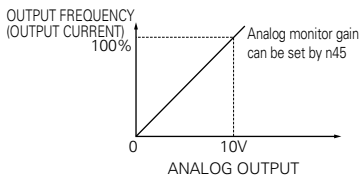
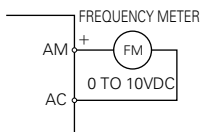

Calibrating frequency meter or ammeter (n45)

Used to adjust analog output gain.

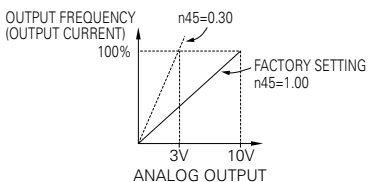
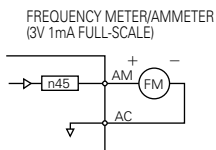

Set the analog output voltage at 100% of output frequency (output current). Frequency meter displays 0 to 60Hz at 0 to 3V.

$$10V \times \begin{matrix} \boxed{\text{n45 Setting}} \\ 0.30 \end{matrix} = 3V$$

Output frequency becomes
100% at this value.

Reducing motor noise or leakage current (n46)

Set inverter output transistor switching frequency (carrier frequency).

Setting	Carrier Frequency	Metallic Noise from Motor	Noise and Current Leakage
7	12 fout (Hz)	Higher ↑ Not audible ↓	Smaller ↑ Larger ↓
8	24 fout (Hz)		
9	36 fout (Hz)		
1	2.5 (kHz)		
2	5.0 (kHz)		
3	7.5 (kHz)		
4	10.0 (kHz)		

Setting values 7, 8, or 9 multiplies output frequency according to output frequency value.

n46=7

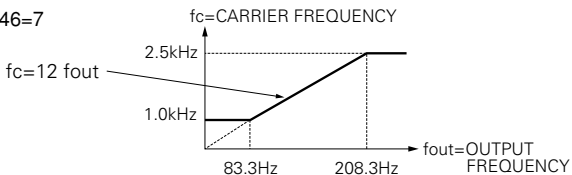

n46=8

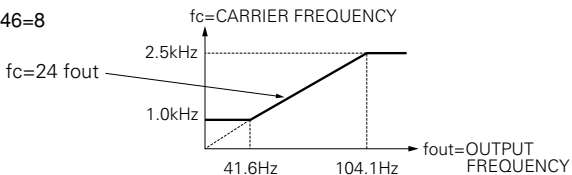

n46=9

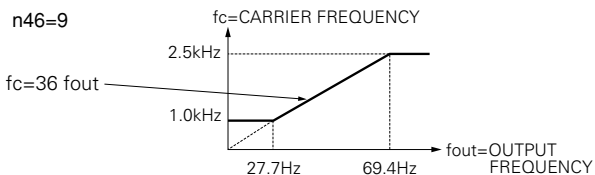

Factory setting varies according to inverter capacity (kVA).

Voltage Class (V)	Capacity (kW)	Initial Setting		Maximum Continuous Output Current (A)	Reduced Current (A)	
		Setting	Carrier Frequency			
200 Single-phase 3-phase	0.1	4	10kHz	0.8	—	
	0.25	4	10kHz	1.6		
	0.55	4	10kHz	3.0		
	1.1	4	10kHz	5.0		
	1.5	3	7.5kHz	8.0		7.0
	2.2	3	7.5kHz	11.0		10.0
	4.0	3	7.5kHz	17.5		16.5
400 3-phase	0.37	3	7.5kHz	1.2	1.0	
	0.55	3	7.5kHz	1.8	1.6	
	1.1	3	7.5kHz	3.4	3.0	
	1.5	3	7.5kHz	4.8	4.0	
	2.2	3	7.5kHz	5.5	4.8	
	3.0	3	7.5kHz	7.2	6.3	
	4.0	3	7.5kHz	9.2	8.1	



- (1) Reduce continuous output current when changing carrier frequency to 4 (10 kHz) for the 200V class (1.5kW or more) and 400V class inverters. Refer to the table above for the reduced current.

[Operation Condition]

- Input power supply voltage : 3-phase 200 to 230V (200V class)
Single-phase 200 to 240V (200V class)
3-phase 380 to 460V (400V class)
- Ambient temperature : -10 to +50°C (14 to 122°F)
(Protection structure: open chassis type IP20)

- (2) If the wiring distance is long, reduce the inverter carrier frequency as described below.

Wiring Distance between Inverter and Motor	Up to 50m	Up to 100m	More than 100m
Carrier frequency (n46 setting)	10kHz or less (n46=1,2,3,4,7,8,9)	5kHz or less (n46=1,2,7,8,9)	2.5kHz or less (n46=1,7,8,9)

- (3) Carrier frequency is automatically reduced to 2.5kHz when Reducing carrier frequency selection at low speed (n75) is set to 1 and the following conditions are satisfied:

Output frequency \leq 5Hz

Output current \geq 110%

Factory setting : 0 (Disabled)

Operator stop key selection (n06)
--

Selects processing when STOP key is pressed during operation from multi-function input terminal.

Setting	Description
0	STOP key effective when running either from multi-function input terminals or communications. When STOP key is pressed, the inverter stops according to the setting of constant n04. At this time, the digital operator displays "S/F" alarm (blinking). This stop command is held in the inverter until both forward and reverse run commands are open, or until run command from communications becomes zero.
1	STOP key ineffective when running either from multi-function input terminals or communications.

■ Selecting Stopping Method

Selecting stopping method (n04)

Selects the stopping method suitable for application.

Setting	Description
0	Deceleration to stop
1	Coast to stop

• Deceleration to stop

Example when accel/decel time 1 is selected

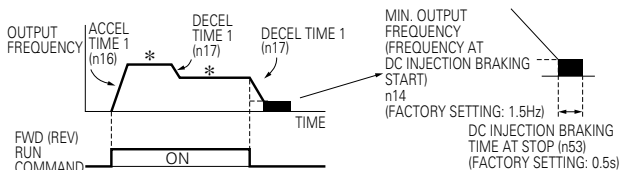

* When frequency reference is changed during running.

Upon termination of the FWD (REV) run command, the motor decelerates at the decel rate determined by the time set to deceleration time 1 (n17) and DC injection braking is applied immediately before stop. DC injection braking is also applied when the motor decelerates by setting frequency reference lower than min. output frequency (n14) with FWD (or REV) run command ON. If the decel time is short or the load inertia is large, overvoltage (OV) fault may occur at deceleration. In this case, increase the decel time.

- Coast to stop

Example when accel/decel time 1 is selected

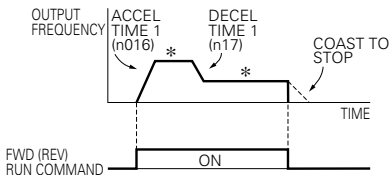

* When frequency reference is changed during running.

Upon removal of the FWD (REV) run command, the motor starts coasting.

Applying DC injection braking

- DC injection braking current (n52)

Sets DC injection braking current in units of 1%. (Inverter rated current=100%)

- DC injection braking time at stop (n53)

Sets the DC injection braking time at stopping in units of 0.1 second. When the setting of n53 is 0, DC injection braking is not performed but inverter output is shut OFF at the timing of DC injection braking start.

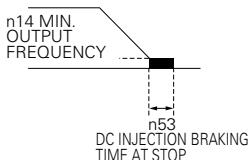

When coasting to a stop is specified in stopping method selection (n04), DC injection braking at stop does not operate.

■ Building Interface Circuits with External Devices

Using input signals

Multi-function input terminal S2 to S5 functions can be changed when necessary by setting constants n36 to n39 respectively. The same value cannot be set to different constant settings.

Setting	Name	Description	Ref.
0	FWD/REV run command (3-wire sequence selection)	Setting enabled only for n37	63
2	Reverse run (2-wire sequence selection)		41
3	External fault (NO contact input)	Inverter stops by external fault signal input. Digital operator display is "EFC".	-
4	External fault (NC contact input)		-
5	Fault reset	Resets the fault. Fault reset not effective with the run signal ON.	43
6	Multi-step speed reference 1		43
7	Multi-step speed reference 2		43
8	Multi-step speed reference 3		43
10	JOG command		44
11	Accel/decel time select		47
12	External baseblock (NO contact input)	Motor coast to a stop by this signal input. Digital operator display is "bb".	-
13	External baseblock (NC contact input)		-
14	Search command from maximum frequency	Speed search reference signal	54
15	Search command from set frequency		54
16	Accel/decel hold command		55
17	LOCAL/REMOTE selection		40
18	Communication/ control circuit terminal selection		65
19	Emergency stop fault (NO contact input)	Inverter stops by emergency stop signal input according to stopping method selection (n04). When frequency coasting to a stop (n04 is set to 1) method is selected, inverter coasts to a stop according to decel time setting 2 (n19). Digital operator display is SFP. (lit at fault, blinking at alarm)	-
20	Emergency stop alarm (NO contact input)		-
21	Emergency stop fault (NC contact input)		-
22	Emergency stop alarm (NC contact input)		-
34	UP/DOWN command	Setting enabled only for n39 (terminal S5)	63
35	Self-test	Setting enabled only for n39 (terminal S5)	-

* Numbers 2 to 5 is displayed in □ corresponding to the terminal numbers S2 to S5 respectively.

Initial setting

No.	Terminal	Initial Setting	Function
n36	S2	2	Reverse run (2-wire sequence selection)
n37	S3	5	Fault reset
n38	S4	3	External fault (NO contact input)
n39	S5	6	Multi-step speed reference 1

Terminal function at 3-wire sequence selection

When 0 is set at the terminal S3 (n37), terminal S1 becomes run command, terminal S2 becomes stop command, and terminal S3 becomes FWD/REV run command.

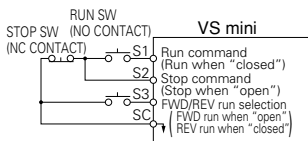

- **LOCAL/REMOTE select (setting: 17)**

Select operation reference either by the digital operator or by the settings of run command selection (n02) and frequency reference selection (n03).

LOCAL/REMOTE select is available only during stop.

Open : Run according to the setting of run command selection (n02) or frequency reference selection (n03).

Closed : Run by frequency reference and run command from the digital operator.

(Example) Set n02 = 1, n03 = 2, n07 = 0.

Open : Run by frequency reference from multi-function input terminal FR and run command from multi-function input terminals S1 to S5.

Closed : Run by potentiometer frequency reference and run command from the digital operator.

- **UP/DOWN command (setting: n39 = 034)**

With the FWD (REV) run command entered, accel/decel is enabled by inputting the UP or DOWN signals to multi-function input terminals S4 and S5 without changing the frequency reference, so that operation can be performed at the desired speed. When UP/DOWN commands are specified by n39, any function set to n38 becomes disabled; terminal S4 becomes an input terminal for the UP command and terminal S5 for the DOWN command.

Multi-function Input Terminal S4 (UP command)	Closed	Open	Open	Closed
Multi-function Input Terminal S5 (DOWN command)	Open	Closed	Open	Closed
Operation Status	Accel	Decel	Hold	Hold

Time Chart at UP/DOWN Command Input

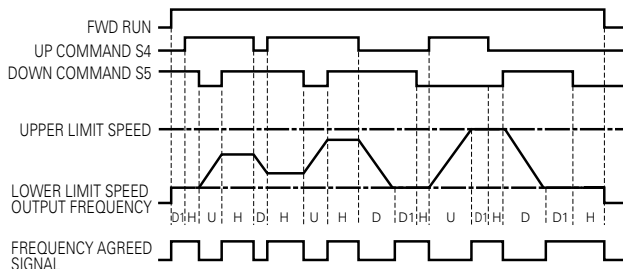

- U = UP (accelerating) status
- D = DOWN (decelerating) status
- H = HOLD (constant speed) status
- U1 = UP status, clamping at upper limit speed
- D1 = DOWN status, clamping at lower limit speed

Notes :

- When UP/DOWN command is selected, the upper limit speed is set regardless of frequency reference.

$$\text{Upper limit speed} = \text{Max. output frequency (n09)} \\ \times \text{Frequency reference upper limit (n30)/100\%}$$

- Lower limit value is either min. output frequency (n14) or max. output frequency (n09) \times frequency reference lower limit (n31)/100% (whichever is larger.).
- When the FWD (REV) run command is input, operation starts at the lower limit speed without an UP/DOWN command.
- If the jog command is input while running by the UP/DOWN command, the jog command has priority.
- Multi-step speed reference 1 to 3 is not effective when UP/DOWN command is selected. Multi-step speed reference is effective during running in hold status.
- When "1" is set for HOLD output frequency memory selection (n62), output frequency can be recorded during HOLD.

Setting	Description
0	Output frequency is not recorded during HOLD.
1	When HOLD status is continued for 5 seconds or longer, the output frequency during HOLD is recorded and the inverter restarts at the recorded frequency.

- Communication/multi-function input terminal selection input (setting: 18)
(This function is effective when option card is installed)
Operation can be changed from communication command, or from multi-function input terminal or digital operator command.
Run command from communication and frequency reference are effective when multi-function input terminal for this setting is “Closed.”
Run command in LOCAL/REMOTE mode and frequency reference are effective when “Open.”

Using output signals (n40)

Multi-function output terminal MA and MB functions can be changed when necessary by setting constant n057.

- Terminal MA and MB functions: Set to n40

Setting	Name	Description	Ref.page
0	Fault	Closed when inverter fault occurs.	-
1	In operation	Closed when either FWD/REV command is input or voltage is output from the inverter.	-
2	Agreed frequency	Closed when setting frequency agrees with inverter output frequency.	66
3	Zero speed	Closed when inverter output frequency is less than min. output frequency.	-
4	Frequency detection	Output frequency \geq Frequency detection level (n58)	52
5	Frequency detection	Output frequency \leq Frequency detection level (n58)	52
6	Overtorque detection (NO contact output)	—	51
7	Overtorque detection (NC contact output)	—	51
10	Minor fault	Closed when the alarm is indicated.	-
11	Base blocked	Closed when the inverter output is shut off.	-
12	Operation mode	Closed when “LOCAL” is selected by LOCAL/REMOTE selection.	-
13	Inverter operation ready	Closed when inverter fault is not detected, and operation is ready.	-
14	Fault restart	Closed during fault retry	-
15	In UV	Closed when undervoltage is detected.	-
16	In reverse run	Closed during reverse run.	-
17	In speed search	Closed when inverter conducts speed search.	-
18	Data output from communication	Operates multi-function output terminal independently from inverter operation (by MEMOBUS communication)	74

Initial setting of multi-function output terminal

No.	Terminals	Initial Setting
n40	MA, MB	1 (in operation)

- Frequency agreed signal (setting=2)

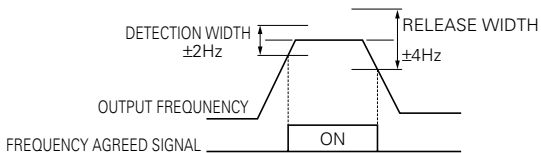

■ Setting Frequency by Current Reference Input

When setting frequency by inputting current reference (4-20mA or 0-20mA) from the control circuit terminal FR, switch the DIP switch SW8 on the control circuit board to “I” side.

SW8 is accessed by removing the option cover.

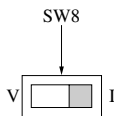

SW8

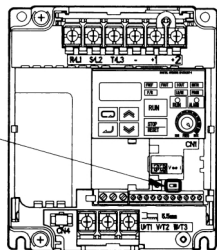

Never input voltage reference to control circuit terminal FR when DIP switch SW8 is switched to “I” side.

Current reference selection

After changing DIP switch (V/I switch of SW8), PRESS **PRGM** on the digital operator, then set the following constants.

4-20mA....n03 = 3

0-20mA....n03 = 4

- Setting : n02 = 0, n03 = 3 or 4

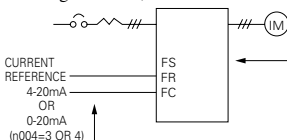

Press the digital operator keys to run or stop the inverter. Switch run and stop direction by setting F/R LED.

Set frequency by the analog current signal [0-100% (max. frequency) / 4-20mA or 0-20mA] connected to the control circuit terminal.

- Setting : n02 = 1, n03 = 3 or 4

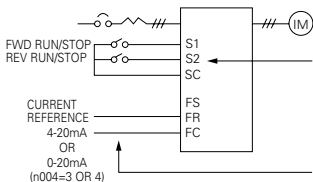

Switch run/stop and FWD/REV run with switching device connected to the control circuit terminal.

Multi-function input terminal S2 is set to Reverse run / stop (n36 = 2).

Set frequency by the analog current signal [0-100% (max. frequency) / 4-20mA or 0-20mA] connected to the control circuit terminal.

Frequency reference gain (n41)/bias (n42) can be set even when current reference input is selected. For details, refer to “Adjusting frequency setting signal” on page 45.

■ Preventing Motor from Stalling (Current Limit)

Automatically adjusts the output frequency and output current according to the load to continue operation without stalling the motor.

- Stall prevention (current limit) level during acceleration (n56)
Sets the stall prevention (current limit) level during acceleration in units of 1% (Inverter rated current = 100%).

Factory setting: 170%

A setting of 200% disables the stall prevention (current limit) during acceleration. During acceleration, if the output current exceeds the value set for n56, acceleration stops and frequency is maintained. When the output current goes down to the value set for n56, acceleration starts.

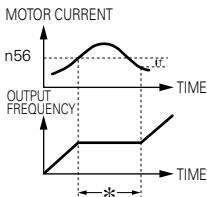

*Stops the acceleration to prevent the motor from stalling.

†Release width (hysteresis) of stall prevention during accel is approx. 5% of inverter rated current.

In the constant output area [output frequency > max. voltage output frequency (n11)], following equation automatically decreases the stall prevention (current limit) level during acceleration.

Stall prevention (current limit) level during accel in constant output area

= Stall prevention (current limit) level during accel (n56)

× $\frac{\text{Max. voltage output frequency (n11)}}{\text{Output frequency}}$

Output frequency

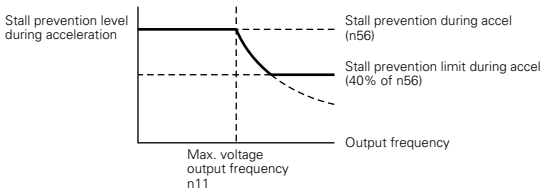

- Stall prevention (current limit) level during running (n57)

Sets the stall prevention (current limit) level during running in units of 1% (Inverter rated current = 100%).

* Factory setting: 160%

A setting of 200% disables the stall prevention (current limit) during running.

If stall prevention action current at agreed speed exceeds the value set for n57 for longer than 100msec, deceleration starts.

When the output current exceeds the value set for n57, deceleration continues. When the output current goes down to the value set for n57, acceleration starts, up to the set frequency.

Stall prevention accel/decel settings during operation are: currently selected acceleration time 1 (n16), deceleration time 1 (n17) and acceleration time 2 (n18) and deceleration time 2 (n19).

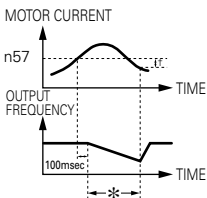

* reduces frequency prevent speed loss
 † at acceleration start, output current hysteresis is approx., 5% of inverter rated current.

- Stall prevention (current limit) function during deceleration (n55)

To prevent overvoltage during deceleration, the inverter automatically lengthen the deceleration time according to the value of main circuit DC voltage.

Setting	Stall prevention (current limit) during deceleration
0	Provided
1	Not Provided

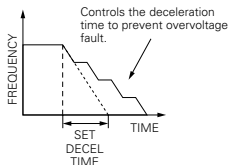

■ Decreasing Motor Speed Fluctuation

Slip compensation

As the load becomes larger, motor speed is reduced and motor slip value is increased. The slip compensating function controls the motor speed at a constant value even if the load varies.

When inverter output current is equal to the motor rated current (n32), the compensation frequency is added to the output frequency.

$$\begin{aligned} \text{Compensation frequency} &= \text{Motor rated slip (n64)} \\ &\times \frac{\text{Output current} - \text{Motor no-load current (n65)}}{\text{Motor rated current (n32)} - \text{Motor no-load current (n65)}} \\ &\times \text{Slip compensation gain (n66)} \end{aligned}$$

Constants

Constants No.	Name	Unit	Setting range	Initial Setting
n32	Motor rated current	0.1A	0 to 120% of inverter rated current	*
n64	Motor rated slip	0.1Hz	0.0 to 20Hz	*
n65	Motor no-load current	1%	0 to 99% (100%=Motor rated current n32)	*
n66	Slip compensation gain	0.1	0.0 to 2.5	0.0
n67	Slip compensation time constant	0.1s	0.0 to 25.5s When 0.0s is set, delay time becomes 2.0s	2.0s

* Differs depending on inverter capacity.

Notes : 1. Slip compensation is not performed in the following condition:

- Output frequency < min. output frequency (n14)
- Slip compensation is not performed during regeneration.
- Slip compensation is not performed when motor rated current (n32) is set to 0.0A.

■ Motor Protection

Motor overload detection

The VS mini protects against motor overload with a built-in electronic thermal overload relay.

- **Motor rated current (electronic thermal reference current, n32)**
Set to the rated current value shown on the motor nameplate.

Note: Setting to 0.0A disables the motor overload protective function.

- **Motor overload protection selection (n33, n34)**

n33 Setting	Electronic Thermal Characteristics
0	Applied to general-purpose motor
1	Applied to inverter motor
2	Electronic thermal overload protection not provided

Constants No.	Name	Unit	Setting Range	Initial Setting
n34	Protection constant selection	1min	1 to 60min	8min

The electronic thermal overload function monitors motor temperature, based on inverter output current and time, to protect the motor from overheating. When electronic thermal overload relay is enabled, an “**OL**” error occurs, shutting OFF the inverter output and preventing excessive overheating in the motor. When operating with one inverter connected to one motor, an external thermal relay is not needed. When operating several motors with one inverter, install a thermal relay on each motor.

- General-purpose motor and inverter motor

Induction motors are classified as general-purpose motors or inverter motors, based on their cooling capabilities. Therefore, the motor overload function operates differently between these two motor types.

Example of 200V class motor

	Cooling Effect	Torque Characteristics	Electronic Thermal overload
General-purpose Motor	Effective when operated at 50/60Hz from commercial power supply.	<p>Base Frequency 60Hz (V/f for 60Hz, 220V Input Voltage) For low-speed operation, torque must be limited in order to stop motor temperature rise.</p>	"OL" error (motor overload protection) occurs when continuously operated at 50/60Hz or less at 100% load.
Inverter Motor	Effective even when operated at low speed (approx. 6Hz)	<p>Base Frequency 60Hz (V/f for 60Hz, 220V Input Voltage) Use an inverter motor for continuous operation at low speed.</p>	Electronic thermal overload protection not activated even when continuously operated at 50/60Hz or less at 100% load.

■ Selecting Cooling Fan Operation

In order to increase lifetime, the cooling fan can be set to operate only when inverter is running.

n35 = 0 (initial setting) : Operates only when inverter is running (Continues operation for 1 minute after inverter is stopped.)

= 1

: Operates with power ON

■ Using MEMOBUS (MODBUS) Communications

Serial communication is available with VS mini using programmable controller (MEMOCON series) and MEMOBUS. In order to perform serial communications, RS-485/422 interface card (optional) must be installed. Refer to MEMOBUS Instruction Manual (Manual No.: TOEZ-C736-70.1) for details of communications.

○ MEMOBUS (MODBUS) communications

MEMOBUS system is composed of a single master (PLC) and slaves (1 to 31 VS-mini units).

Communication between master and slave (serial communication) is controlled according to the master program with the master initiating communication and the slave responding.

The master sends a signal to one slave at a time. Each slave has a pre-registered address No., and the master specifies the number and conduct signal communications. The slave receives the communication to carry out designated functions and reply to the master.

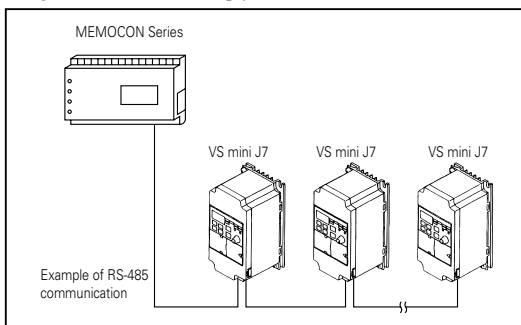

Communications specifications

Interface	RS-422, RS-485
Synchronization	Asynchronous (Start-stop synchronization)
Communication parameters	Baud rate : Selected from 2400/4800/9600/19200 bps Data length : 8 bits fixed Parity : Selected from even/odd/none Stop bits : 1 bit fixed
Communication protocol	MEMOBUS (MODBUS) (RTU mode only)
Max. number of inverters that can be connected	31 units (When using RS-485)

■ Using Constant Copy Function

Constant copy function

The digital operator for remote operation (Model JVOP-146, Optional) can store constants for one inverter. A backup power supply is not necessary since EEPROM is used.

Note: When using a digital operator for remote operation, use with a remote interface unit for remote operation (optional) and the cable for remote operation (optional). Refer to the VS mini J7 catalog (Literature No. KAE-S606-12) for details.

Constant copy function is possible only for the inverters with same product series and power supply specifications. However, some constants may not be copied. It is also impossible to copy constants between VS mini and VS-606V7 inverters.

The prohibition of the reading of constants from the inverter can be set at n77. The constant data cannot be changed when this constant is set.

If any alarm occurs during constant copy, the PRGM will blink and copying will continue.

• Constant copy function selection (n76)

Depending on the setting of n76 for constant copy function selection, the following functions are available:

- (1) Read all the constants from the inverter (READ) and store them in EEPROM in the digital operator.
- (2) Copies the constants stored in the digital operator to the inverter (COPY).
- (3) Verify that the constants in the digital operator and the constants in the inverter are the same (VERIFY).
- (4) Displays the maximum applicable motor capacity and the voltage class of the inverter that has the constants stored in the digital operator.
- (5) Displays the software number of the inverter that has the constants stored in the digital operator.

Constant No.	Name	Unit	Setting Range	Initial Setting
n76	Constant copy function selection	—	rdy: READY rEd: READ CPy: COPY vFy: VERIFY vA: Inverter capacity display Sno: Software No. display	rdy

- Prohibiting constant read selection (n77)

Select this function to prevent accidentally overwriting the constants stored in EEPROM or in the digital operator. Reading is not possible when this constant is set to 0.

The constant data stored in the digital operator are protected from accidental overwriting.

When reading is performed while this constant is set to 0, PrE will blink. Press the DSPL or ENTER and return to the constant No.display.

Constant No.	Name	Unit	Setting Range	Initial Setting
n77	Constant read selection prohibit	1	0: READ prohibited 1: READ allowed	0

READ function

Reads out the constants in batch from the inverter and stores them in EEPROM inside the digital operator. When the read-out is executed, the previously stored constants data in the EEPROM are cleared and replaced with the newly entered constants.

[Example] Store the constants read out from the inverter, in the EEPROM inside the digital operator.

	Explanation	Opretor display
<ul style="list-style-type: none"> • Enable the setting of the constants n01 to n79. 	<ul style="list-style-type: none"> • Press DSPL to light [PRGM]. • Press ENTER to display the set value. • Change the set value to 4 by pressing Δ or ∇ key. • Press ENTER. 	<p>n 0 4 ; (Can be a different constant No.) 0 (Lit) (Can be a different set value.) ; (Blinks) ; (Lit for one second.) ↓ n 0 4 ; (The constant is displayd.)</p>
<ul style="list-style-type: none"> • Set contant read prohibited selection (n77) to READ enabled. *1 	<ul style="list-style-type: none"> • Change the constant No. to n77 by pressing Δ or ∇ key. • Press ENTER to display the set value. • Change the set value to 1 by pressing Δ or ∇ key. • Press ENTER. 	<p>n 7 7 0 (Lit) ; (Blinks) ; (Lit for one second) ↓ n 7 7 (The constant displayed.)</p>
<ul style="list-style-type: none"> • Execute read-out (READ) by constant copy Function selection (n76). 	<ul style="list-style-type: none"> • Change the constant No. by pressing Δ or ∇ key. • Press ENTER to display the set value. • Change the set value to rEd by pressing Δ or ∇ key. • Press ENTER. 	<p>n 7 6 r 0 4 (Lit) r Ed (Lit) r Ed (Blinks while executing READ) ↓ End (End is displayed after the execution of READ is completed.) n 7 6 (The constant is displayed.)</p>
<ul style="list-style-type: none"> • Set Constant read prohibited selection (n77) to READ disabled. *2 	<ul style="list-style-type: none"> • Press DSPL or ENTER • Change the constant No. to n77 by pressing Δ or ∇ key. • Press ENTER to display the set value. • Chage the set value to 0 by pressing Δ or ∇ key. • Press ENTER. 	<p>n 7 7 ; (Lit) 0 (Blinks) 0 (Lit for one minute) ↓ n 7 7 (the constant No. is display ed.)</p>

*1 When READ is enabled (n77=1), this setting is not necessary.

*2 The setting is not necessary unless the READ prohibition is selected.

COPY function

Writes the constants stored inside the digital operator in batch to the inverter. Write-in is possible only for the inverters with same product series and power supply specifications.

Therefore, writing from 200 V class to 400 V class (or vice versa), from V/f control mode to vector control mode (or vice versa), and from VS mini to VS-606V7 are not possible.

Constant Copy Function Selection (n76), Constant Read Selection Prohibit (n77), Fault history (n78), Software version No. (n79), and hold output frequency are not written.

vAE will appear (blinking) when the capacity of the inverters differs. Press ENTER to continue writing in (the COPY function).

Press STOP/RESET to stop the COPY function.

Following constants are not written if the inverter capacity is different.

Constant No.	Name	Constant No.	Name
n09 to n15	V/ f setting	n64	Motor rated slip
n32	Motor rated current	n65	Motor no-load current
n46	Carrier frequency selection		

[Example] Write the constants from EEROM inside the digital operator to the inverter

Explanation		Operator display
<ul style="list-style-type: none"> Enable the settings for the constants n01 to n79. Execute write-in (COPY) by Constant Copy Function Selection (n76). 	<ul style="list-style-type: none"> Press DSPL to light [PRGM] Press ENTER to display the set value. Change the set value to 4 by pressing Δ or ∇ key. Press ENTER. Change the constant No. to n76 by pressing Δ or ∇ key. Press ENTER to display the set value. Change the set value to CPy by pressing Δ or ∇ key. Press ENTER. Press DSPL or ENTER. 	<p>$n76$; (Can be a different constant No.)</p> <p>4 (Lit) (Can be a different set value.)</p> <p>$;$ (Blinks)</p> <p>$;$ (Lit for one second)</p> <p>\downarrow</p> <p>$n76$; (The constant No. is displayed)</p> <p>$n76$</p> <p>$r76$ (Lit)</p> <p>CPy (Lit)</p> <p>CPy (Blinks while executing COPY)</p> <p>\downarrow</p> <p>End (End is displayed when the execution of COPY is completed.)</p> <p>$n76$ (The constant No. is displayed)</p>

A setting range check and matching check for the written-in constants are executed after the constants are written from the digital operator to the inverter. If any constant error is found, the written constants are discarded and the constants stored before writing are restored.

When a setting range error is found, the constant No. where an error occurs is indicated by blinking.

When a matching error is found, \square (\square :a number) is indicated by blinking.

VERIFY function

Collates the constants stored in the digital operator with the constant in the inverter. As well as write-in, VERIFY is possible only for the inverters with same product series and power supply specifications .

When the constants stored in the digital operator correspond to those in the inverter, vFy is displayed by blinking, then End is displayed.

[Example] Collate the constants stored in EEPROM inside the digital operator with the constants in the inverter

Explanation	Operator display
<ul style="list-style-type: none"> Enable the setting for the constans n01 to n79. 	<ul style="list-style-type: none"> Press DSPL to light [PRGM]. Press ENTER to display the set value. Change the set value to 4 by Pressing Δ or ∇ key. Press ENTER.
<ul style="list-style-type: none"> Execute VERIFY by Constant Copy Function selection (n76). 	<ul style="list-style-type: none"> Change the constant No. to n76 by pressing Δ or ∇ key. Press ENTER to display the set value. Change the set value to vFy by pressing Δ or ∇ key. Press ENTER.
<ul style="list-style-type: none"> Display the unmatched constant No. 	<ul style="list-style-type: none"> Press ENTER.
<ul style="list-style-type: none"> Display the constant value in the inverter. 	<ul style="list-style-type: none"> Press ENTER.
<ul style="list-style-type: none"> Display the constant value in the digital operator. 	<ul style="list-style-type: none"> Press Δ key.
<ul style="list-style-type: none"> Continue the execution of VERIFY. 	<ul style="list-style-type: none"> Press DSPL or ENTER.
	<ul style="list-style-type: none"> Operator display sequence: $n01 ;$ (Can be a different constant No.) 0 (Lit) $;$ (Can be a different constant No.) $;$ (Blinks) $;$ (Lit for one second) \downarrow $n01 ;$ (The constant No. is displayed) $n76$ vFy (Lit) vFy (Lit) vFy (Blinks while executing VERIFY) $n09$ (Blinks) (When n09 is unmatched) 000 (Blinks) 000 (Blinks) vFy (Blinks while executing VERIFY) \downarrow End (End is displayed when the execution of VERIFY is completed). $n76$ (The constant No. is displayed)

While an unmatched constant No. is displayed or a constant value is displayed, pressing STOP/RESET interrupts the execution of VERIFY and End is displayed. Pressing DSPL or ENTER returns to the constant No.

Inverter capacity display

The voltage class and maximum applicable motor capacity (whose constants stored in the digital operator are read out) are displayed.

[Example] Display the voltage class and maximum applicable motor capacity for the inverter whose constants stored in EEPROM inside the digital operator

Explanation		Operator display
<ul style="list-style-type: none"> Enable the setting for the constants n01 to n79. 	<ul style="list-style-type: none"> Press DSPL to light [PRGM]. Press ENTER to display the set value. Change the set value to 4 by Pressing Δ or \square key. Press ENTER. 	n04 ; (Can be a different constant No.) 4 (Lit) (Can be a different constant No.) ; (Blinks) ; (Lit for one second) ↓ n04 ; (The constant No. is displayed)
<ul style="list-style-type: none"> Execute Inverter Capacity Display (vA) by Constant copy function selection (n76) 	<ul style="list-style-type: none"> Change the constant No. to n76 by pressing Δ or \square key. Press ENTER to display the set value. Change the set value to vA fy by pressing Δ or \square key. Press ENTER. Press DSPL or ENTER. 	n76 r04 (Lit) vA (Lit) 207 (Lit) (For 20P7) * n76 (The constant No. is displayed)

* The following shows the explanation of inverter capacity display

Voltage class		Max. applicable motor capacity	
		200V class	400V class
B	Single-phase 200V	0.1kW	—
2	Three-phase 200V	0.25kW	0.37kW
4	Three-phase 400V	0.4kW	0.55kW
		0.7kW	1.1kW
		1.5kW	1.5kW
		2.2kW	2.2kW
		—	3.0kW
		4.0kW	4.0kW

Software No. display

The software No. (of the inverter whose constants stored in the digital operator are read out) is displayed.

[Example] Display the software No. of the inverter whose constants stored in EEPROM inside the digital operator

Explanation	Operator display
<ul style="list-style-type: none"> • Enable the setting for the constants n01 to n79. 	<ul style="list-style-type: none"> • Press DSPL to light [PRGM]. • Press ENTER to display the set value. • Change the set value to 4 by Pressing $\overline{\Delta}$ or $\overline{\nabla}$ key. • Press ENTER.
<ul style="list-style-type: none"> • Execute Software No. Display (Sno)* by Constant copy function selection (n76). 	<ul style="list-style-type: none"> • Change the constant No. to n76 by pressing $\overline{\Delta}$ or $\overline{\nabla}$ key. • Press ENTER to display the set value. • Change the set value to Sno by pressing $\overline{\Delta}$ or $\overline{\nabla}$ key. • Press ENTER. • Press DSPL or ENTER.

* Displays Lower 3 digits of the software version.

Display list

Operator display	Description	Corrective action
r dY	Lit : Setting for constant copy function selection enabled	—
r Ed	Lit: READ selected Flashed: READ under execution	—
CPy	Lit: Writing (COPY) selected Blinks: Writing (COPY) under execution	—
vFy	Lit: VERIFY selected Flashed: VERIFY under execution	—
uA	Lit: Inverter capacity display selected	—
Sno	Lit: Software No. Display selected	—
End	Lit: READ, COPY (writing), or VERIFY completed	—
PrE	Blinks: Attempt to execute READ while Constant Read Selection Prohibit (n77) is set to 0.	Confirm the necessity to execute READ, then set constant Read selection Prohibit (n77) to 1 to execute READ.
r dE	Blinks: The constant could not be read properly by READ operation. Or, a main circuit low voltage is detected during READ operation.	Confirm that the main circuit power supply voltage is correct, then re-execute READ.
CSE	Blinks: A sumcheck error occurs in the constant data stored in the digital operator.	The constants stored in the digital operator cannot be used. Re-execute READ to store the constants in the digital operator.
dPS	Blinks: The password for the connected inverter and that for the constant data stored in the digital operator are disagreed. [Ex.]Writing (COPY) from VS mini to VS-606V7	Check if they are the same product series.
ndr	Blinks: No constant data stored in the digital operator.	Execute READ.
CPE	Blinks: Attempt to execute writing (COPY) or VERIFY between different voltage classes or different control modes.	Check each voltage class and control mode.
CYE	Blinks: A main circuit low voltage is detected during writing (COPY) operation.	Confirm that the main circuit power supply voltage is correct, then re-execute writing (COPY).
FQY	Lit: A sumcheck error occurs in the constant data stored in the inverter.	Initialize the constants. If an error occurs again, replace the inverter due to a failure of constant memory element (EEPROM) in the inverter.
uRE	Blinks: Attempt to execute COPY or VERIFY between inverters of different capacities.	Press ENTER to continue the execution of COPY or VERIFY. Press STOP to interrupt the execution of COPY or VERIFY.
.FE	Blinks: A communication error occurs between the inverter and the digital operator.	Check the connection between the inverter and the digital operator. If a communication error occurs during READ operation or writing (COPY) operation, be sure to re-execute READ or COPY.

Note: While rEd, CPy, or vFy is displayed by blinking, key input on the digital operator is disabled.
While rEd, CPy and vFy are not displayed by blinking, pressing DSPL or ENTER redisplay the constant No.

7. MAINTENANCE AND INSPECTION

■ Periodical Inspection

Periodically inspect the inverter as described in the following table to prevent accidents and to ensure high performance with high-reliability.

Location to Check	Check For	Solution
Terminals, unit mounting screws, etc.	Connection hardware is properly seated and securely tightened.	Properly seat and tighten hardware.
Heatsink	Built up dust, dirt, and debris	Blow with dry compressed air : 39.2×10^4 to 58.8×10^4 Pa, 57 to 85 psi (4 to 6kg / cm ²) pressure
Printed circuit board	Accumulation of conductive material or oil mist	Blow with dry compressed air : 39.2×10^4 to 58.8×10^4 Pa, 57 to 85 psi (4 to 6kg / cm ²) pressure If dust or oil cannot be removed, replace the inverter unit.
Power elements and smoothing capacitor	Abnormal odor or discoloration	Replace the inverter unit.
Cooling fan	Abnormal noise or vibration Cumulative operation time exceeding 20,000 hours	Replace the cooling fan.

■ Part Replacement

Inverter's maintenance periods are noted below. Keep them as reference.

Part Replacement Guidelines

Part	Standard Replacement Period	Replacement Method
Cooling fan	2 to 3 years	Replace with new part.
Smoothing capacitor	5 years	Replace with new part. (Determine need by inspection.)
Breaker relays	—	Determine need by inspection.
Fuses	10 years	Replace with new part.
Aluminum capacitors on PCBs	5 years	Replace with new board. (Determine need by inspection.)

Note: Usage conditions are as follows:

- Ambient temperature: Yearly average of 30°C
- Load factor: 80% max.
- Operating rate: 12 hours max. per day

Replacement of cooling fan

- Inverter of W-dimension (width) 68mm (2.68 inches), 140mm (5.51 inches)

1. Removal

- (1) Press the right and left clicks of the fan cover to direction 1, and then pull them to direction 2 to remove the fan cover from the inverter unit.
- (2) Pull the wiring to direction 3 from the fan cover rear face, and remove the protective tube and connector.
- (3) Open the left and right sides of the fan cover to remove the cooling fan from the cover.

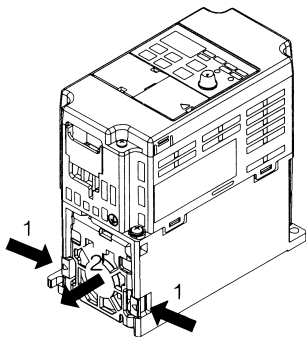

2. Mounting

- (1) Mount the cooling fan on the fan cover. The arrow mark to indicate the wind direction of the cooling fan must be in the opposite side to the cover.
- (2) Connect the connector and mount the protective tube firmly. Mount the connector joint section on the fan cover rear face.
- (3) Mount the fan cover on the inverter. Be sure to mount the right and left clicks of the fan cover on the cooling fin.

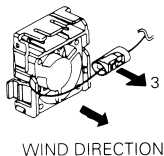

- Inverter of W-dimension (width) 108mm (4.25 inches)

1. Removal

- (1) Remove the front cover, and then remove the cooling fan connector (CN4).
- (2) Press the right and left clicks of the fan cover to direction 1, and pull the fan cover to direction 2 to remove it from the inverter unit. Pull out the wiring from the cable lead-in hole at the bottom of the plastic case.
- (3) Open the right and left sides of the fan cover to remove the cover from the cooling fan.

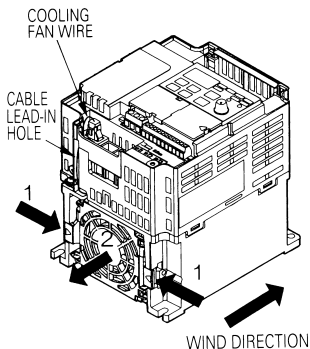

2. Mounting

- (1) Mount the cooling fan on the fan cover. The arrow mark to indicate the wind direction must be opposite to the cover.
- (2) Mount the fan cover on the inverter. Be sure to mount the right and left clicks of the fan cover on the cooling fin. Lead in the wiring from the cable lead-in hole at the bottom of the plastic case to the inside of the inverter.
- (3) Connect the wiring to the cooling fan connector (CN4) and mount the front cover and the terminal cover.

8. FAULT DIAGNOSIS

■ Protective and Diagnostic Function

This section describes the alarm and fault displays, explanations for fault conditions and corrective actions to be taken if the VS mini malfunctions.







< Corrective actions for models without digital operator >





1. Input fault reset or cycle the power supply OFF and ON.
2. When a fault cannot be corrected:
Turn the power supply OFF and check the wiring and control logic.





<Corrective Actions of Models with Digital Operator>

☀ : ON ⦿ : BLINKING ● : OFF

Alarm Display and Contents

Alarm Display		Inverter Status	Explanation	Causes and Corrective Actions
Digital Operator	RUN ALARM (Green) (Red)			
 Blinking		Warning Fault contacts do not change state.	UV (Main circuit low voltage) Main circuit DC voltage drops below the low-voltage detection level while the inverter output is OFF. 200V: Main circuit DC voltage drops below approx. 200V. (160V for single-phase) 400V: Main circuit DC voltage drops below approx. 400V.	Check the following : • Power supply voltage • Main circuit power supply wiring is connected. • Terminal screws are securely tightened.
 Blinking	 		OV (Main circuit overvoltage) Main circuit DC voltage exceeds the overvoltage detection level while the inverter output is OFF. Detection level : 200V class: approx. 410V or more 400V class: approx. 820V or more	Check the power supply voltage.
 Blinking			OH (Cooling fin overheat) Intake air temperature rises while the inverter output is OFF.	Check the intake air temperature.
 Blinking			CAL (MEMOBUS communications waiting) Correct data has not been received from the PLC when the constants n02 (run command selection) is 2 or n03 (frequency reference selection) is 6, and power is turned ON.	Check communication devices, and transmission signals.

Alarm Display		Inverter Status	Explanation	Causes and Corrective Actions
Digital Operator	RUN ALARM (Green) (Red)			
OP□ Blinking	 	Warning Fault contacts do not change state.	OP□ (Constant setting error when the constant setting is performed through the MEMOBUS communications) OP1: Two or more values are set for multi-function input selection. (constants n36 to n39) OP2: Relationship among V / f constants is not correct. (constants n09, n11, n12, n14) OP3: Setting value of motor rated current exceeds 120% of inverter rated current. (constant n32) OP4: Upper / lower limit of frequency reference is reversed. (constants n30, n31) OP5: Setting values of jump frequencies 1 and 2 are not appropriate. (constants n49, n50) OP9: Carrier frequency setting is incorrect. (constant n46)	Check the setting values.
OL3 Blinking			OL 3 (Overtorque detection) Motor current exceeded the preset value in constant n60.	Reduce the load, and expand the accel / decel time.
SEr Blinking	 		SER (Sequence error) Inverter receives LOCAL / REMOTE select command or communication / control circuit terminal changing signals from the multi-function terminal while the inverter is outputting.	Check the external circuit (sequence).

Alarm Display		Inverter Status	Explanation	Causes and Corrective Actions
Digital Operator	RUN (Green) ALARM (Red)			
bb Blinking		Warning Fault contacts do not change state.	BB (External baseblock) Baseblock command at multi-function terminal is active, the inverter output is shut OFF (motor coasting). Temporary condition is cleared when input command is removed.	Check the external circuit (sequence).
EF Blinking			EF (Simultaneous FWD/REV run commands) When FWD and REV run commands are simultaneously input for over 500ms, the inverter stops according to constant n04.	Check the external circuit (sequence).
STP Blinking	  or  		STP (Operator function stop)  is pressed during running by the control circuit terminals FWD / REV command, or by the run command from communications. The inverter stops according to constant n04. STP(Emergency stop) Inverter receives emergency stop alarm signal. Inverter stops according to constant n04.	Open FWD/REV command of control circuit terminals . Check the external circuit (sequence).
FRn Blinking			FAN(Cooling fan fault) Cooling fan is locked.	Check the following: • Cooling fan • Cooling fan wiring is not connected.
CE Blinking			CE (MEMOBUS communications fault)	Check the communication devices or signals.

Fault Display and Contents

Fault Display		Inverter Status	Explanation	Causes and Corrective Actions
Digital Operator	RUN ALARM (Green) (Red)			
OC		Protective Operation Output is shut OFF and motor coasts to a stop. 	OC (Overcurrent) Inverter output current momentarily exceeds approx. 200% of rated current. (Control power supply fault) Voltage fault of control power supply is detected.	<ul style="list-style-type: none"> • Short circuit or grounding at inverter output side • Excessive load GD² • Extremely rapid accel/ decel time (constants n16 to n19) • Special motor used • Starting motor during coasting • Motor of a capacity greater than the inverter rating has been started. • Magnetic contactor open/closed at the inverter output side <p style="text-align: center;">↓</p> <ul style="list-style-type: none"> • Cycle power. If the fault remains, replace the inverter.
GF			GF (Ground fault) Ground fault current at the inverter output exceeded inverter rated current.	<ul style="list-style-type: none"> • Check that motor insulation has not deteriorated. • Check the connection between inverter and motor.
OV	●		OV (Main circuit over-voltage) Main circuit DC voltage exceeds the overvoltage detection level because of excessive regenerative energy from the motor. Detection level: 200V: Stops at main circuit DC voltage below approx. 410V. 400V: Stops at main circuit DC voltage approx. 820V or more.	<ul style="list-style-type: none"> • Insufficient decel time (constants n17 and n19) • Lowering of minus load (elevator, etc.) <p style="text-align: center;">↓</p> <ul style="list-style-type: none"> • Increase decel time.
UV1			UV1 (Main circuit low voltage) Main circuit DC voltage drops below the low-voltage detection level while the inverter output is ON. 200V: Stops at main circuit DC voltage below approx. 200V.(160V for single-phase) 400V: Stops at main circuit DC voltage approx. 400V or more.	<ul style="list-style-type: none"> • Reduction of input power supply voltage • Open phase of input supply • Occurrence of momentary power loss <p style="text-align: center;">↓</p> Check the following : <ul style="list-style-type: none"> • Power supply voltage • Main circuit power supply wiring is connected. • Terminal screws are securely tightened.

Fault Display		Inverter Status	Explanation	Causes and Corrective Actions
Digital Operator	RUN ALARM (Green) (Red)			
OH		Protective Operation Output is shut OFF and motor coasts to a stop.	OH (Cooling fin overheat) Temperature rise because of inverter overload operation or intake air temperature rise.	<ul style="list-style-type: none"> Excessive load Improper V/f pattern setting Insufficient accel time if the fault occurs during acceleration Intake air temperature exceeding 122°F (50°C) Cooling fan stops ⇕ Check the following : <ul style="list-style-type: none"> Load size V/f pattern setting (constants n09 to n15) Intake air temperature.
OL1	● ☀		OL1 (Motor overload) Motor overload protection operates by built-in electronic thermal overload relay.	<ul style="list-style-type: none"> Check the load size or V/f pattern setting (constants n09 to n15) Set the motor rated current shown on the nameplate by constant n32.
OL2			OL2 (Inverter overload) Inverter overload protection operates by built-in electronic thermal overload relay.	<ul style="list-style-type: none"> Check the load size or V/f pattern setting (constants n09 to n15) Check the inverter capacity.
OL3			OL3 (Overtorque detection) Inverter output current exceeded the preset value in constant n60. When overtorque is detected, inverter performs operation according to the preset setting of constant n59.	Check the driven machine and correct the cause of the fault, or increase the value of constant n60 up to the highest value allowed for the machine.

Fault Display		Inverter Status	Explanation	Causes and Corrective Actions
Digital Operator	RUN (Green) ALARM (Red)			
<i>EF□</i>	● ☀	Protective Operation Output is shut OFF and motor coasts to a stop.	EF□ (External fault) Inverter receives an external fault input from control circuit terminal. EF0: External fault reference through MEMOBUS communications EF2: External fault input command from control circuit terminal S2 EF3: External fault input command from control circuit terminal S3 EF4: External fault input command from control circuit terminal S4 EF5: External fault input command from control circuit terminal S5	Check the external circuit (sequence).
<i>F00</i>			CPF-00 Initial memory fault has detected.	Cycle power. If the fault remains, replace the inverter.
<i>F01</i>			CPF-01 ROM error has detected.	Cycle power. If the fault remains, replace the inverter.
<i>F04</i>			CPF-04 EEPROM fault of inverter control circuit is detected.	<ul style="list-style-type: none"> Record all constant data and initialize the constants. (Refer to page 36 for constant initialization.) Cycle power. If the fault remains, replace the inverter.

Fault Display		Inverter Status	Explanation	Causes and Corrective Actions
Digital Operator	RUN ALARM (Green) (Red)			
<i>F05</i>	● ☀	Protective Operation Output is shut OFF and motor coasts to a stop.	CPF-05 A/D converter fault is detected.	Cycle power. If the fault remains, replace the inverter.
<i>F06</i>			CPF-06 • Option card connecting fault • A non-corresponding option card is connected.	Remove power to the inverter. Check the connection of the digital operator. Verify inverter software number.
<i>F07</i>			CPF-07 Operator control circuit (EEPROM or A/D converter) fault	Cycle power. If the fault remains, replace the inverter.
<i>CE</i>			CE(MEMOBUS communications fault) Normal reception of communication data is not possible.	Check the communication devices or communication signals.
<i>STP</i>	☀ or ● ☀	Stops according to constant	STP(Emergency stop) The inverter stops according to constant n04 after receiving the emergency stop fault signal.	Check the external circuit (sequence).
— (OFF)	● ●		<ul style="list-style-type: none"> • Insufficient power supply voltage • Control power supply fault • Hardware fault 	Check the following : <ul style="list-style-type: none"> • Power supply voltage • Main circuit power supply wiring is connected. • Terminal screws are securely tightened. • Control sequence. Replace the inverter.

Note : For display/clear of fault history, refer to page 34.

■ Troubleshooting

Trouble	Cause	Corrective Actions
The motor does not operate when an external operation signal is input.	The operation method selection is wrong. The run command (n02) is not set to Control Circuit Terminal.	Set the run command (n02) to Control Circuit Terminal.
	A 3-wire sequence is in effect. The multi-function input method (n37) is set to 3-wire sequence, and the S2 control terminal is not closed.	To use a 3-wire sequence, make the wiring so that the S2 control terminal is closed. To use a 2-wire sequence, set the multi-function input (n37) to a value other than 3-wire sequence.
	The frequency reference is too low. The input frequency reference is lower than the setting for the min.output frequency (n14).	Input a frequency reference greater than the min. output frequency (n14).
	Local mode is in effect.	Set the LO/RE selection of the digital operator to RE.
	The SW setting for the reference selection is wrong. Example: The reference 4-20mA is input, but the SW is set to "V".	For analog input, make sure that the frequency reference (n03) and SW settings are correct.
The motor stops. The torque is not output.	The stall prevention level during acceleration is too low. Because the stall prevention level during acceleration (n56) is set too low, the output current reaches the set level, the output frequency is stopped, and the acceleration time is lengthened.	Check if the stall prevention level during acceleration (n56) is set to an appropriate value.
	The stall prevention level during running is too low. Because the stall prevention level during running (n57) is set too low, the output current reaches the set level, and the speed drops.	Check if the stall prevention level during running (n57) is set to an appropriate value.
	The load is too heavy. If the load is too heavy, stall prevention is activated, the output frequency is stopped, and the acceleration time is lengthened.	Lengthen the set acceleration time (n16). Reduce the load.

Trouble	Cause	Corrective Actions
	When the maximum frequency was changed, the maximum voltage frequency was also changed.	To increase the speed of a general-purpose motor, only change the maximum frequency.
	The V/f set value is too low.	Set the V/f (n09 to n15) according to the load characteristics.
The motor speed is unstable. The motor speed fluctuates when operating with a light load.	The stall prevention level during running is too low. Because the stall prevention level during running (n57) is too low, the output current reaches the set level and the speed drops.	Check if the stall prevention level during running (n57) is set to an appropriate value.
	The load is too heavy. If the load is too heavy, stall prevention is activated, the output frequency is stopped, and the acceleration time is lengthened.	Reduce the load.
	The carrier frequency is too high. If operating the motor with a light load, a high carrier frequency may cause the motor speed to fluctuate.	Decrease the carrier frequency (n46).
	The V/f set value is too high for a low speed operation. Because the set value for the V/f is too high, over-excitation occurs at low speeds.	Set the V/f (n09 to n15) according to the load characteristics.
	The maximum frequency and base frequency were incorrectly adjusted. Example: To operate a 60 Hz motor at 40 Hz or less, the maximum frequency and base frequency are set to 40 Hz.	Set the maximum frequency and the base frequency according to the motor specifications.
	The inverter is used for an operation at 1.5 Hz or less.	Do not use the VS mini for an operation that runs at 1.5 Hz or less. For an operation at 1.5 Hz or less, use a different inverter model.
	The analog reference input is unstable and has noise interference.	Increase the set value for the filter time constant.

Trouble	Cause	Corrective Actions
The digital operator does not turn ON.	The power is not being supplied. The breaker or other component on the power input side is not turned ON, and the power is being not supplied.	Check if the power is being supplied.

9. SPECIFICATIONS

■ Standard Specifications (200V Class)

Voltage Class		200V single- / 3-phase						
Model CIMR-J7*Z□□□□	3-phase	20P1	20P2	20P4	20P7	21P5	22P2	24P0
	Single-phase	B0P1	B0P2	B0P4	B0P7	B1P5	—	—
Max. Applicable Motor Output kW (HP)*		0.1 (0.13)	0.25 (0.23)	0.55 (0.5)	1.1 (1)	1.5 (2)	2.2 (3)	4.0 (5)
Output Characteristics	Inverter Capacity (kVA)	0.3	0.6	1.1	1.9	3.0	4.2	6.7
	Rated Output Current (A)	0.8	1.6	3	5	8	11	17.5
	Max. Output Voltage (V)	3-phase, 200 to 230V (proportional to input voltage) Single-phase, 200 to 240V (proportional to input voltage)						
	Max. Output Frequency (Hz)	400Hz(Programmable)						
Power Supply	Rated Input Voltage and Frequency	3-phase, 200 to 230V, 50/60Hz Single-phase, 200 to 240V, 50/60Hz						
	Allowable Voltage Fluctuation	-15 to + 10%						
	Allowable Frequency Fluctuation	±5%						
Control Characteristics	Control Method	Sine wave PWM (V/f control)						
	Frequency Control Range	0.1 to 400Hz						
	Frequency Accuracy (Temperature Change)	Digital reference: ± 0.01% (-10 to + 50°C) Analog reference: ± 0.5% (25 ± 10°C)						
	Frequency Setting Resolution	Digital reference: 0.1Hz (less than 100Hz) / 1Hz (100Hz or more) Analog reference: 1 / 1000 of max. output frequency						
	Output Frequency Resolution	0.01Hz						
	Overload Capacity	150% rated output current for one minute						
	Frequency Reference Signal	0 to 10VDC (20kΩ), 4 to 20mA (250Ω), 0 to 20mA (250Ω), Frequency setting potentiometer (Selectable)						
	Accel/Decel Time	0.0 to 999 sec. (accel / decel time are independently programmed)						
	Braking Torque	Short-term average deceleration torque † 0.1, 0.25kW (0.13HP, 0.25HP): 150% 0.55, 1.1kW (0.5HP, 1HP): 100% 1.5kW (2HP): 50% 2.2kW(3HP) or more: 20% Continuous regenerative torque: Approx. 20%						
V/f Characteristics	Possible to program any V / f pattern							

* Based on a standard 4-pole motor for max. applicable motor output.

† Shows deceleration torque for uncoupled motor decelerating from 60Hz with the shortest possible deceleration time.

Voltage Class		200V single- / 3-phase						
Model CIMR-J7*Z□□□□	3-phase	20P1	20P2	20P4	20P7	21P5	22P2	24P0
	Single-phase	B0P1	B0P2	B0P4	B0P7	B1P5	-	-
Protective Functions	Motor Overload Protection	Electronic thermal overload relay						
	Instantaneous Overcurrent	Motor coasts to a stop at approx. 200% of inverter rated current						
	Overload	Motor coasts to a stop after 1 minute at 150% of inverter rated output current						
	Overvoltage	Motor coasts to a stop if DC bus voltage exceed 410V						
	Undervoltage	Stops when DC bus voltage is approx. 200V or less (approx. 160V or less for single-phase series)						
	Momentary Power Loss	Following items are selectable : Not provided (stops if power loss is 15ms or longer), continuous operation if power loss is approx. 0.5s or shorter, continuous operation						
	Cooling Fin Overheat	Protected by electronic circuit						
	Stall Prevention Level	Can be set individual level during accel / decel, provided / not provided available during coast to a stop						
	Cooling Fan Fault	Protected by electronic circuit (fan lock detection)						
	Ground Fault	Protected by electronic circuit (rated output current level)						
	Power Charge Indication	RUN lamp stays ON or digital operator LED stays ON. (Charge LED is provided for 400V) ON until the DC bus voltage becomes 50V or less.						
Other Functions	Input Signals	Multi-function Input	Four of the following input signals are selectable: Reverse run (3-wire sequence), fault reset, external fault (NO / NC contact input), multi-step speed operation, Jog command, accel / decel time select, external baseblock (NO / NC contact input), speed search command, accel / decel hold command, LOCAL / REMOTE selection, communication / control circuit terminal selection, emergency stop fault emergency stop alarm					
	Output Signals	Multi-function Output *	Following output signals are selectable (1 NO / NC contact output) : Fault, running, zero speed, at frequency, frequency detection (output frequency \leq or \geq set value), during overtorque detection, minor error, during baseblock, operation mode, inverter run ready, during fault retry, during UV, during speed search, data output through communication					
		Standard Functions	Full-range automatic torque boost, slip compensation, DC injection braking current / time at start/stop, frequency reference bias /gain, frequency reference with built-in potentiometer, constant copy, [MEMOBUS communications (RS-485/422, max. 19.2K bps) (optional)]					

* Minimum permissible load: 5VDC, 10mA (as reference value)

Voltage Class		200V single- / 3-phase							
Model CIMR-J7*Z□□□□	3-phase	20P1	20P2	20P4	20P7	21P5	22P2	24P0	
	Single-phase	B0P1	B0P2	B0P4	B0P7	B1P5	-	-	
Other Functions	Display	Status Indicator LED	RUN and ALARM provided as LED's						
		Digital Operator	Available to monitor frequency reference, output frequency, output current						
	Terminals	Main circuit: screw terminals Control circuit: plug-in screw terminal							
	Wiring Distance between Inverter and Motor	100m (328ft) or less †							
Enclosure		Open chassis							
Cooling Method		Cooling fan is provided for the following models: 200V, 0.75kW (1HP) or large inverters (3-phase) 200V, 1.5kW (2HP) or large inverters (single-phase) Other models are self-cooling							
Environmental Conditions	Ambient Temperature		Open chassis : -10 to +50°C (14 to 122°F) (not frozen)						
	Humidity		95%RH or less (non-condensing)						
	Storage Temperature *		-20 to +60°C (-4 to +140°F)						
	Location		Indoor (free from corrosive gases or dust)						
	Elevation		1000m (3280ft) or less						
	Vibration		Up to 9.8m / S ² (1G) at less than 20Hz, up to 2m / S ² (0.2G) at 20 to 50Hz						

* Temperature during shipping (for short period)

† If the wiring distance between inverter and motor is long, reduce the inverter carrier frequency.

For details, refer to "Reducing motor noise or leakage current (n46)" on page 57.

■ Standard Specifications (400V Class)

Voltage Class		400V 3-phase						
Model CIMR-J7*Z□□□□	3- phase	40P2	40P4	40P7	41P5	42P2	43P0	44P0
Max. Applicable Motor Output kW (HP) *		0.37 (0.5)	0.55 (0.75)	1.1 (1.5)	1.5 (2)	2.2 (3)	3.0 (4)	4.0 (5)
Output Characteristics	Inverter Capacity (kVA)	0.9	1.4	2.6	3.7	4.2	5.5	7.0
	Rated Output Current (A)	1.2	1.8	3.4	4.8	5.5	7.2	9.2
	Max. Output Voltage (V)	3-phase, 380 to 460V (proportional to input voltage)						
	Max. Output Frequency (Hz)	400Hz(Programmable)						
Power Supply	Rated input Voltage and Frequency	3-phase, 380 to 460V, 50/60Hz						
	Allowable Voltage Fluctuation	-15 to + 10%						
	Allowable Frequency Fluctuation	±5%						
Control Characteristics	Control Method	Sine wave PWM (V/f control)						
	Frequency Control Range	0.1 to 400Hz						
	Frequency Accuracy (Temperature Change)	Digital reference: ± 0.01%, -10 to + 50°C (14 to 122°F) Analog reference: ± 0.5%, 25 ± 10°C (59 to 95°F)						
	Frequency Setting Resolution	Digital reference: 0.1Hz (less than 100Hz) / 1Hz (100Hz or more) Analog reference: 1 / 1000 of max. output frequency						
	Output Frequency Resolution	0.01Hz						
	Overload Capacity	150% rated output current for one minute						
	Frequency Reference Signal	0 to 10VDC (20kΩ), 4 to 20mA (250Ω), 0 to 20mA (250Ω) Frequency setting potentiometer (Selectable)						
	Accel/Decel Time	0.0 to 999 sec. (accel / decel time are independently programmed)						
	Braking Torque	Short-term average deceleration torque† 0.37kW: 150% 0.55kW, 1.1kW: 100% 1.5kW (2HP) : 50% 2.2kW (3HP) or more: 20% Continuous regenerative torque: Approx. 20%						
V/f Characteristics	Possible to program any V / f pattern							

* Based on a standard 4-pole motor for max. applicable motor output.

† Shows deceleration torque for uncoupled motor decelerating from 60Hz with the shortest possible deceleration time.

Voltage Class		400V 3-phase						
Model CIMR-J7*Z□□□□	3- phase	40P2	40P4	40P7	41P5	42P2	43P0	44P0
Protective Functions	Motor Overload Protection	Electronic thermal overload relay						
	Instantaneous Overcurrent	Motor coasts to a stop at approx. 200% of inverter rated current						
	Overload	Motor coasts to a stop after 1 minute at 150% of inverter rated output current						
	Overvoltage	Motor coasts to a stop if DC bus voltage exceed 820V						
	Undervoltage	Stops when DC bus voltage is approx. 400V or less						
	Momentary Power Loss	Following items are selectable : Not provided (stops if power loss is 15ms or longer), continuous operation if power loss is approx. 0.5s or shorter, continuous operation						
	Cooling Fin Overheat	Protected by electronic circuit						
	Stall Prevention Level	Can be set to individual levels during accel / decel, provided / not provided available during coast to a stop						
	Cooling Fan Fault	Protected by electronic circuit (fan lock detection)						
	Ground Fault	Protected by electronic circuit (rated output current level)						
Power Charge Indication	Charge LED is provided. ON until the DC bus voltage becomes 50V or less.							
Other Functions	Input Signals	Multi-function Input	Four of the following input signals are selectable: Reverse run (3-wire sequence), fault reset, external fault (NO / NC contact input), multi-step speed operation, Jog command, accel / decel time select, external baseblock (NO / NC contact input), speed search command, accel / decel hold command, LOCAL / REMOTE selection, communication / control circuit terminal selection, emergency stop fault emergency stop alarm					
	Output Signals	Multi-function Output *	Following output signals are selectable (1 NO / NC contact output,) : Fault, running, zero speed, at frequency, frequency detection (output frequency \leq or \geq set value), during overtorque detection, minor error, during baseblock, operation mode, inverter run ready, during fault retry, during UV, during speed search, data output through communication					
	Standard Functions		Full-range automatic torque boost, slip compensation, DC injection braking current / time at start/stop frequency reference bias /gain, frequency reference with built-in potentiometer, constant copy, [MEMOBUS communications (RS-485/422, max. 19.2K bps) (optional)]					

* Minimum permissible load: 5VDC, 10mA (as reference value)

Voltage Class			400V 3-phase						
Model		3-phase	40P2	40P4	40P7	41P5	42P2	43P0	44P0
CIMR-J7*Z□□□□									
Other Functions	Display	Status Indicator LED	RUN and ALARM provided as standard LED's						
		Digital Operator	Available to monitor frequency reference, output frequency, output current						
	Terminals		Main circuit: screw terminals Control circuit: plug-in screw terminal						
	Wiring Distance between Inverter and Motor		100m (328ft) or less [†]						
Enclosure			Open chassis						
Cooling Method			Cooling fan is provided for the following models: 400V, 1.5kW (3HP) or large inverters (3-phase) Other models are self cooling						
Environmental Conditions	Ambient Temperature		Open chassis: -10 to +50°C (14 to 122°F) (not frozen)						
	Humidity		95%RH or less (non-condensing)						
	Storage Temperature*		-20 to +60°C (-4 to 140°F)						
	Location		Indoor (free from corrosive gases or dust)						
	Elevation		1000m (3280ft) or less						
	Vibration		Up to 9.8m / S ² (1G) at less than 20Hz, up to 2m / S ² (0.2G) at 20 to 50Hz						

* Temperature during shipping (for short period)

† If the wiring distance between inverter and motor is long, reduce the inverter carrier frequency.

For details, refer to "Reducing motor noise or leakage current (n46)" on page 57.

■ Standard Wiring

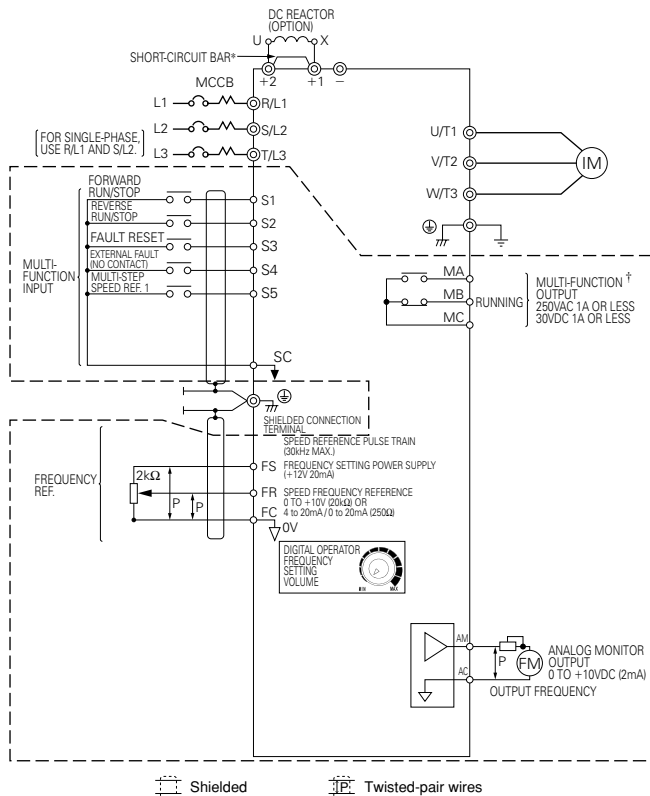

[---]: Only basic insulation (Protective class 1, overvoltage category II) is provided for the control circuit terminals. Additional insulation may be necessary in the end product to conform to CE requirements.

* Short-circuit bar should be removed when connecting DC reactor.

† Minimum permissible load: 5VDC, 10mA (as reference value)

Terminal description

Type	Terminal	Name	Function (Signal Level)				
Main Circuit	R/L1, S/L2, T/L3	AC power supply input	Use main circuit power input. (Use terminals R/L1 and S/L2 for single -phase inverters. Never use terminal T/L3.)				
	U/T1, V/T2, W/T3	Inverter output	Inverter output				
	+2, +1	DC reactor connection	When connecting optional DC reactor, remove the main circuit short-circuit bar between +2 and +1.				
	+1, -	DC power supply input	DC power supply input (+1: positive -: negative) *				
	⊕	Grounding	For grounding (according to the local grounding code)				
Control Circuit	Input	Sequence	S1	Forward run input	Closed: FWD run, open: REV run	Photo-coupler insulation, 24VDC, 8mA	
			S2	Multi-function input selection 2	Factory setting closed: REV run, open: FWD run		
			S3	Multi-function input selection 3	Factory setting: Fault reset		
			S4	Multi-function input selection 4	Factory setting: External fault (NO contact)		
			S5	Multi-function input selection 5	Factory setting: Multi-step speed reference 1		
			SC	Multi-function input selection common	For control signal		
	Output	Frequency reference	FS	Power for frequency setting	+12V (permissible current 20mA max.)		
			FR	Master speed frequency reference	0 to +10VDC (20kΩ) or 4 to 20mA (250kΩ) or 0 to 20mA (250Ω) (1/1000 resolution)		
			FC	Frequency reference common	0V		
		Multi-function contact output	MA	NO contact output	Factory setting: running	Contact capacity 250VAC 1A or less, 30VDC 1A or less	
			MB	NC contact output			
			MC	Contact output common			
			AM	Analog monitor output	Factory setting: Output frequency 0 to +10VDC	0 to +10VDC, 2mA or less, 8-bit resolution	
AC	Analog monitor common	0V					

* DC power supply input terminal is not applied to CE/UL standards.

† Minimum permissible load: 5VDC, 10mA (as reference value)

■ Sequence Input Connection with NPN/PNP Transistor

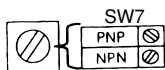

When connecting sequence inputs (S1 to S5) with transistor, turn the rotary switch SW7 depending on the polarity (0V common: NPN side, +24V common: PNP side).

Factory setting: NPN side

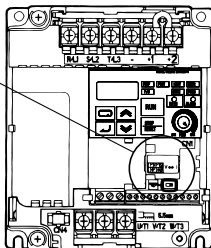

Sequence connection with NPN transistor (0V common)

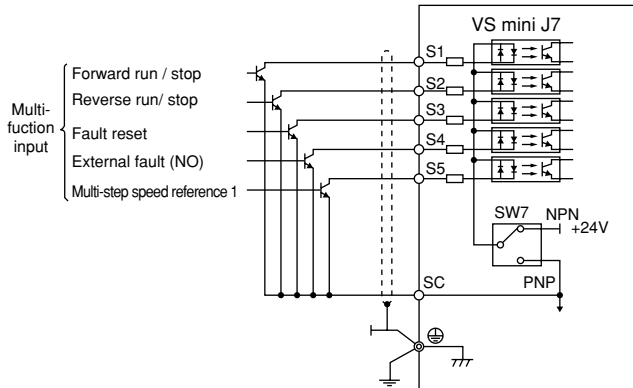

Sequence connection with PNP transistor (+24V common)

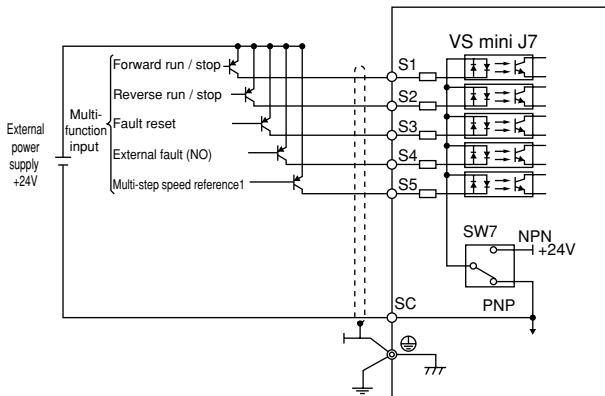

■ Dimensions/Heat Loss

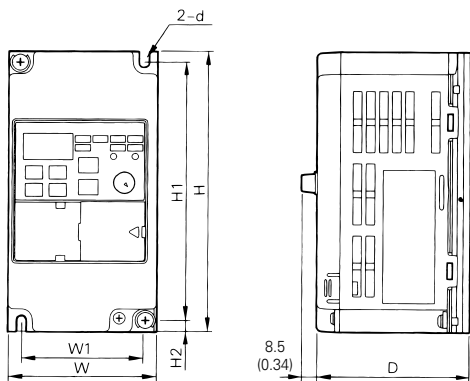

Fig. 1

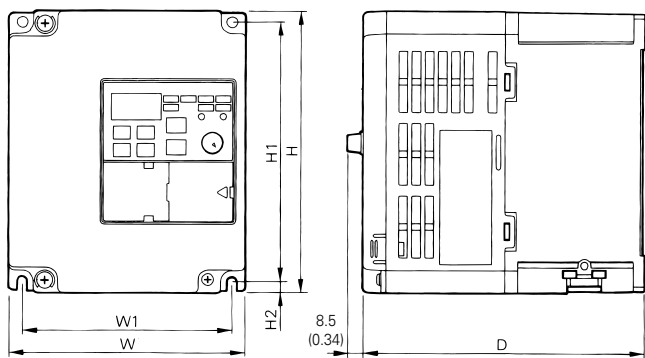

Fig. 2

Dimensions in mm (inches)/mass in kg (lb)/Heat Loss (W)

Voltage class	Capacity kW	W	H	D	W1	H1	H2	d	Mass	Heat Loss (W)			Fig.
										Heatsink	Unit	Total	
200V 3-phase	0.1	68 (2.68)	128 (5.04)	70 (2.76)	56 (2.20)	118 (4.65)	5 (0.20)	M 4	0.5 (1.10)	3.7	9.3	13.0	1
	0.25	68 (2.68)	128 (5.04)	70 (2.76)	56 (2.20)	118 (4.65)	5 (0.20)	M 4	0.5 (1.10)	7.7	10.3	18.0	1
	0.55	68 (2.68)	128 (5.04)	102 (4.02)	56 (2.20)	118 (4.65)	5 (0.20)	M 4	0.8 (1.77)	15.8	12.3	28.1	1
	1.1	68 (2.68)	128 (5.04)	122 (4.80)	56 (2.20)	118 (4.65)	5 (0.20)	M 4	0.9 (1.98)	28.4	16.7	45.1	1
	1.5	108 (4.25)	128 (5.04)	129 (5.08)	96 (3.78)	118 (4.65)	5 (0.20)	M 4	1.3 (2.86)	53.7	19.1	72.8	2
	2.2	108 (4.25)	128 (5.04)	154 (6.06)	96 (3.78)	118 (4.65)	5 (0.20)	M 4	1.5 (3.31)	60.4	34.4	94.8	2
	4.0	140 (5.51)	128 (5.04)	161 (6.34)	128 (5.04)	118 (4.65)	5 (0.20)	M 4	2.1 (4.62)	96.7	52.4	149.1	2
200V single-phase	0.1	68 (2.68)	128 (5.04)	70 (2.76)	56 (2.20)	118 (4.65)	5 (0.20)	M 4	0.5 (1.10)	3.7	10.4	14.1	1
	0.25	68 (2.68)	128 (5.04)	70 (2.76)	56 (2.20)	118 (4.65)	5 (0.20)	M 4	0.5 (1.10)	7.7	12.3	20.0	1
	0.55	68 (2.68)	128 (5.04)	112 (4.41)	56 (2.20)	118 (4.65)	5 (0.20)	M 4	0.9 (1.98)	15.8	16.1	31.9	1
	1.1	108 (4.25)	128 (5.04)	129 (5.08)	96 (3.78)	118 (4.65)	5 (0.20)	M 4	1.5 (3.31)	28.4	23.0	51.4	2
	1.5	108 (4.25)	128 (5.04)	154 (6.06)	96 (3.78)	118 (4.65)	5 (0.20)	M 4	1.5 (3.31)	53.7	29.1	82.8	2
400V 3-phase	0.37	108 (4.25)	128 (5.04)	81 (3.19)	96 (3.78)	118 (4.65)	5 (0.20)	M 4	1.0 (2.20)	9.4	13.7	23.1	2
	0.55	108 (4.25)	128 (5.04)	99 (3.90)	96 (3.78)	118 (4.65)	5 (0.20)	M 4	1.1 (2.43)	15.1	15.0	30.1	2
	1.1	108 (4.25)	128 (5.04)	129 (5.08)	96 (3.78)	118 (4.65)	5 (0.20)	M 4	1.5 (3.31)	30.3	24.6	54.9	2
	1.5	108 (4.25)	128 (5.04)	154 (6.06)	96 (3.78)	118 (4.65)	5 (0.20)	M 4	1.5 (3.31)	45.8	29.9	75.7	2
	2.2	108 (4.25)	128 (5.04)	154 (6.06)	96 (3.78)	118 (4.65)	5 (0.20)	M 4	1.5 (3.31)	50.5	32.5	83.0	2
	3.0	140 (5.51)	128 (5.04)	161 (6.34)	128 (5.04)	118 (4.65)	5 (0.20)	M 4	2.1 (4.62)	58.2	37.6	95.8	2
	4.0	140 (5.51)	128 (5.04)	161 (6.34)	128 (5.04)	118 (4.65)	5 (0.20)	M 4	2.1 (4.62)	73.4	44.5	117.9	2

■ Recommended Peripheral Devices

It is recommended that the following peripheral devices should be mounted between the AC main circuit power supply and VS mini input terminals R/L1, S/L2, and T/L3.

- **MCCB (Molded-case circuit breaker)/fuse :**
Be sure to connect it for wiring protection.
- **Magnetic contactor:**
Mount a surge suppressor on the coil (refer to the table shown below.)
When using a magnetic contactor to start and stop the inverter, do not exceed one start per hour.

Recommended MCCB and magnetic contactor

• 200V 3-phase

VS mini model	J7 *Z 20P1	J7 *Z 20P2	J7 *Z 20P4	J7 *Z 20P7	J7 *Z 21P5	J7 *Z 22P2	J7 *Z 24P0
Capacity (kVA)	0.3	0.6	1.1	1.9	3.0	4.2	6.7
Rated Output Current (A)	0.8	1.6	3	5	8	11	17.5
MCCB type NF30 (MITSUBISHI)	5A	5A	5A	10A	20A	20A	30A
Magnetic contactor type HI (YASKAWA CONTROL)	HI-7E	HI-7E	HI-7E	HI-7E	HI-10-2E	HI-10-2E	HI-20E
Fuse (UL Class RK5)	5A	5A	5A	10A	20A	20A	30A

• 200V single-phase

VS mini model	J7 *Z B0P1	J7 *Z B0P2	J7 *Z B0P4	J7 *Z B0P7	J7 *Z B1P5
Capacity (kVA)	0.3	0.6	1.1	1.9	3.0
Rated Output Current (A)	0.8	1.5	3	5	8
MCCB type NF30, NF50 (MITSUBISHI)	5A	5A	10A	20A	20A
Magnetic contactor type HI (YASKAWA CONTROL)	HI-7E	HI-7E	HI-7E	HI-10-2E	HI-15E
Fuse (UL Class RK5)	5A	5A	10A	20A	20A

• 400V 3-phase

VS mini model	J7 *Z 40P2	J7 *Z 40P4	J7 *Z 40P7	J7 *Z 41P5	J7 *Z 42P2	J7 *Z 43P0	J7 *Z 44P0
Capacity (kVA)	0.9	1.4	2.6	3.7	4.2	5.5	7.0
Rated Output Current (A)	1.2	1.8	3.4	4.8	5.5	7.2	9.2
MCCB type NF30, NF50 (MITSUBISHI)	5A	5A	5A	10A	10A	20A	20A
Magnetic contactor type HI (YASKAWA CONTROL)	HI-7E	HI-7E	HI-7E	HI-10-2E	HI-10-2E	HI-10-2E	HI-10-2E
Fuse (UL Class RK5)	5A	5A	5A	10A	10A	20A	20A

Surge suppressors

Surge Suppressors		Model	Specifications	Code No.
Coils and relays		DCR2-		
200V to 230V	Large size magnetic contactors	50A22E	250VAC 0.5 μ F 200 Ω	C002417
	Control relays MY-2, -3 (OMRON) HH-22, -23 (FUJI) MM-2, -4 (OMRON)	10A25C	250VAC 0.1 μ F 100 Ω	C002482

- **Ground fault interrupter:**

Select a ground fault interrupter not affected by high frequencies. To prevent malfunctions, the current should be 200mA or more and the operating time 0.1 sec. or more.

Example : • NV series by Mitsubishi Electric Co., Ltd. (manufactured in 1988 and after)

- EGSG series by Fuji Electric Co., Ltd. (manufactured in 1984 and after)

- **AC and DC reactor :**

Install an AC reactor to connect to a power supply transformer of large capacity (600kVA or more) or to improve power factor on the power supply side.

- **Noise filter:**

Use a noise filter exclusively for inverter if radio noise generated from the inverter causes other control devices to malfunction.

NOTE

1. Never connect a general LC/RC noise filter to the inverter output circuit.
2. Do not connect a phase advancing capacitor to the I/O sides and/or a surge suppressor to the output side.
3. When a magnetic contactor is installed between the inverter and the motor, do not turn it ON/OFF during operation.

For the details of the peripheral devices, refer to the catalog.

■ Constants List

- Addition of constants accompanied by the upgraded software version
The constants marked with #1 are applicable for the upgraded software version No. VSP 020011 or later.
- Constants that can be changed during operation
The constants whose numbers are in bold can be changed during operation.

No.	Register No. for Transmission	Name	Setting Range	Setting Unit	Initial Setting	User Setting	Ref. Page
01	0101H	Password	0, 1, 6, 12, 13	1	1		36
02	0102H	Run command selection	0 to 2	1	0		41
03	0103H	Frequency reference selection	0 to 6	1	0 (Note 4)		42
04	0104H	Selecting stopping method	0, 1	1	0		60
05	0105H	Selecting reverse run prohibited	0, 1	1	0		43
06	0106H	Stop key function	0, 1	1	0		59
07	0107H	Selecting frequency reference in local mode	0, 1	1	0 (Note 4)		42
08	0108H	Frequency reference setting method from digital operator	0, 1	1	0		42
09	0109H	Max. output frequency	50.0 to 400Hz	0.1Hz (less than 100Hz)	50.0Hz		37
10	010AH	Max. voltage	1 to 255V (Note 1)	0.1V	200V (Note 1)		37
11	010BH	Max. voltage output frequency	0.2 to 400Hz	1Hz (100Hz or more)	50.0Hz		37
12	010CH	Mid. output frequency	0.1 to 399	1Hz (100Hz or more)	1.3Hz		37
13	010DH	Mid. output frequency voltage	1 to 255V (Note 1)	1V	12V (Note 1)		37
14	010EH	Min. output frequency	0.1 to 10.0Hz	0.1Hz	1.3Hz		37
15	010FH	Min. output frequency voltage	1 to 50V (Note 1)	0.1V	12V (Note 1)		37
16	0110H	Acceleration time 1	0.0 to 999	0.1s (less than 100s) 1s (100s or more)	10.0s		47
17	0111H	Deceleration time 1	0.0 to 999	0.1s (less than 100s) 1s (100s or more)	10.0s		47
18	0112H	Acceleration time 2	0.0 to 999	0.1s (less than 100s) 1s (100s or more)	10.0s		47
19	0113H	Deceleration time 2	0.0 to 999	0.1s (less than 100s) 1s (100s or more)	10.0s		47
20	0114H	S-curve selection	0 to 3	1	0		49

No.	Register No. for Transmission	Name	Setting Range	Setting Unit	Initial Setting	User Setting	Ref. Page
21	0115H	Frequency reference 1 (Master speed frequency reference)	0.0 to 400	0.1Hz (less than 100Hz) 1Hz (100Hz or more)	6.0Hz		43
22	0116H	Frequency reference 2	0.0 to 400	0.1Hz (less than 100Hz) 1Hz (100Hz or more)	0.0Hz		43
23	0117H	Frequency reference 3	0.0 to 400	0.1Hz (less than 100Hz) 1Hz (100Hz or more)	0.0Hz		43
24	0118H	Frequency reference 4	0.0 to 400	0.1Hz (less than 100Hz) 1Hz (100Hz or more)	0.0Hz		43
25	0119H	Frequency reference 5	0.0 to 400	0.1Hz (less than 100Hz) 1Hz (100Hz or more)	0.0Hz		43
26	011AH	Frequency reference 6	0.0 to 400	0.1Hz (less than 100Hz) 1Hz (100Hz or more)	0.0Hz		43
27	011BH	Frequency reference 7	0.0 to 400	0.1Hz (less than 100Hz) 1Hz (100Hz or more)	0.0Hz		43
28	011CH	Frequency reference 8	0.0 to 400	0.1Hz (less than 100Hz) 1Hz (100Hz or more)	0.0Hz		43
29	011DH	Jog frequency	0.0 to 400	0.1Hz (less than 100Hz) 1Hz (100Hz or more)	6.0Hz		44
30	011EH	Frequency reference upper limit	0 to 110%	1%	100%		47
31	011FH	Frequency reference lower limit	0 to 110%	1%	0%		47
32	0120H	Motor rated current	0 to 120% of inverter rated current	0.1A	(Note 2)		72
33	0121H	Electronic thermal motor protection	0 to 2	1	0		72
34	0122H	Electronic thermal motor protection time constant setting	1 to 60 min	1min	8min		72
35	0123H	Selecting cooling fan operation	0, 1	1	0		73

No.	Register No. for Transmission	Name	Setting Range	Setting Unit	Initial Setting	User Setting	Ref. Page
36	0124H	Multi-function input selection 2	2 to 8 10 to 22	1	2		62
37	0125H	Multi-function input selection 3	0, 2 to 8 10 to 22	1	5		62
38	0126H	Multi-function input selection 4	2 to 8 10 to 22	1	3		62
39	0127H	Multi-function input selection 5	2 to 8 10 to 22, 34, 35	1	6		62
40	0128H	Multi-function output selection	0 to 7, 10 to 18	1	1		65
41	0129H	Analog frequency reference gain	0 to 255%	1%	100%		45
42	012AH	Analog frequency reference bias	-99 to 99%	1%	0%		45
43	012BH	Filter time constant for analog frequency	0.00 to 2.00s	0.01s	0.10s		-
44	012CH	Multi-function analog output (terminal AM-AC)	0, 1	1	0		56
45	012DH	Analog monitor gain	0.00 to 2.00	0.01	1.00		56
46	012EH	Carrier frequency selection	1 to 4, 7 to 9	1	4 (Note 3)		57
47	012FH	Momentary power loss ridethrough method	0 to 2	1	0		48
48	0130H	Automatic retry attempts	0 to 10 times	1	0 time		53
49	0131H	Jump frequency 1	0.0 to 400Hz	0.01Hz (less than 100Hz) / 0.1Hz (100Hz or more)	0.0Hz		53
50	0132H	Jump frequency 2	0.0 to 400Hz	0.01Hz (less than 100Hz) / 0.1Hz (100Hz or more)	0.0Hz		53
51	0133H	Jump frequency range	0.0 to 25.5Hz	0.1Hz	0.0Hz		53
52	0134H	DC injection braking current	0 to 100%	1%	50%		54
53	0135H	DC injection braking time at stop	0.0 to 25.5%	0.1s	0.5s		61
54	0136H	DC injection braking time at start	0.0 to 25.5%	0.1s	0.0s		54
55	0137H	Stall prevention during deceleration	0, 1	1	0		70
56	0138H	Stall prevention during deceleration	30 to 200%	1%	170%		69
57	0139H	Stall prevention during running	30 to 200%	1%	160%		70
58	013AH	Frequency detection level	0.0 to 400Hz	0.1Hz (less than 100Hz) / 1Hz (100Hz or more)	0.0Hz		52

No.	Register No. for Transmission	Name	Setting Range	Setting Unit	Initial Setting	User Setting	Ref. Page
59	013BH	Overtorque detection function	0 to 4	1	0		51
60	013CH	Overtorque detection level	30 to 200%	1%	160%		51
61	013DH	Overtorque detection time	0.1 to 10.0s	0.1s	0.1s		51
62	013EH	Hold output	0, 1	1	0		64
63	013FH	Torque compensation gain	0.0 to 2.5	0.1	1.0		39
64	0140H	Motor rated slip	0.0 to 20.0Hz	0.1Hz	(Note 2)		–
65	0141H	Motor no-load current	0 to 99%	1%	(Note 2)		–
66	0142H	Slip compensation gain	0.0 to 2.5	0.1	0.0		71
67	0143H	Slip compensation time constant	0.0 to 25.5s	0.1s	2.0s		71
68	0144H	MEMOBUS timeout selection	0 to 4	1	0		–
69	0145H	MEMOBUS frequency reference and frequency monitor unit	0 to 3	1	0		–
70	0146H	MEMOBUS slave address	0 to 32	1	0		–
71	0147H	MEMOBUS BPS selection	0 to 3	1	2		–
72	0148H	MEMOBUS parity selection	0 to 2	1	0		–
73	0149H	Transmission waiting time	10 to 65ms	1ms	10ms		–
74	014AH	RTS control	0, 1	1	0		–
75 #1	014BH	Reducing carrier frequency selection at low speed	0, 1	1	0		58
76 #1	014CH	Constant copy function selection	rdy, rEd, Cpy, vFy, vA, Sno		rdy		75
77 #1	014DH	Constant read selection prohibit	0, 1	1	0		76
78	014EH	Fault history	Stores, displays most recent alarm	Setting disabled	–		34
79	014FH	Software version No.	Displays lower-place 3 digits of software No.	Setting disabled	–		–

- Notes:
- Upper limit of setting range and initial setting are doubled at 400 class.
 - Changes depending on inverter capacity Refer to the next page.
 - Changes depending on inverter capacity. Refer to page 58.
 - Initial setting of the model with digital operator (without potentiometer) is 1. Setting can be set to 0 by constant initialization.

■ 200V class 3-phase

No.	Name	Unit	Initial setting							
			0.1kW	0.25kW	0.55kW	1.1kW	1.5kW	2.2kW	–	4.0kW
–	Inverter capacity	kW	0.1kW	0.25kW	0.55kW	1.1kW	1.5kW	2.2kW	–	4.0kW
n32	Motor rated current	A	0.6	1.1	1.9	3.3	6.2	8.5	–	14.1
n64	Motor rated slip	Hz	2.5	2.6	2.9	2.5	2.6	2.9	–	3.3
n65	Motor no-load current	%	72	73	62	55	45	35	–	32

■ 200V class single-phase

No.	Name	Unit	Initial setting				
			0.1kW	0.25kW	0.55kW	1.1kW	1.5kW
–	Inverter capacity	kW	0.1kW	0.25kW	0.55kW	1.1kW	1.5kW
n32	Motor rated current	A	0.6	1.1	1.9	3.3	6.2
n64	Motor rated slip	Hz	2.5	2.6	2.9	2.5	2.6
n65	Motor no-load current	%	72	73	62	55	45

■ 400V class 3-phase

No.	Name	Unit	Initial setting							
			–	0.37kW	0.55kW	1.1kW	1.5kW	2.2kW	3.0kW	4.0kW
–	Inverter capacity	kW	–	0.37kW	0.55kW	1.1kW	1.5kW	2.2kW	3.0kW	4.0kW
n32	Motor rated current	A	–	0.6	1.0	1.6	3.1	4.2	7.0	7.0
n64	Motor rated slip	Hz	–	2.5	2.7	2.6	2.5	3.0	3.2	3.2
n65	Motor no-load current	%	–	73	63	52	45	35	33	33

NOTES

NOTES

NOTES

NOTES

NOTES

OMRON YASKAWA MOTION CONTROL B.V. – Wegalaan 65 – 2132 JD Hoofddorp – The Netherlands
phone: +31 (0) 23 568 74 00 – fax: +31 (0) 23 568 74 88 – www.omronyaskawa.com

Note: Specifications subject to change without notice.
Manual No. TOE5606-12F-0Y

